



We care for the things that matter MOST

88Light CATALOGUE

88Light B.V.

TEL: +31(0)614 526 090

E-mail: Sales@88Light.com

Address: Tradeboulevard 3. 4761RL Zevenbergen The Netherlands

Website: www.88Light.com

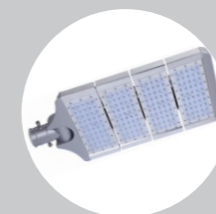

**LED LIGHTING
PRODUCTS**

88Light Vision

88Light is fully committed to comply with all applicable laws and regulations, including the RoHS Directive which restricts the use of certain hazardous materials in electrical and electronic products. 88Light's goal is to meet and exceed compliance obligations of the RoHS Directive on a global basis



Our planet is facing a very real threat of climate change, caused primarily by human activity. Every year we release more and more greenhouse gases into the atmosphere, despite our goal to reduce our carbon footprint. The burning of fossil fuels and our reliance on coal and oil to feed our need for power have left the planet in peril.

COMPANY CORE COMPETITIVENESS

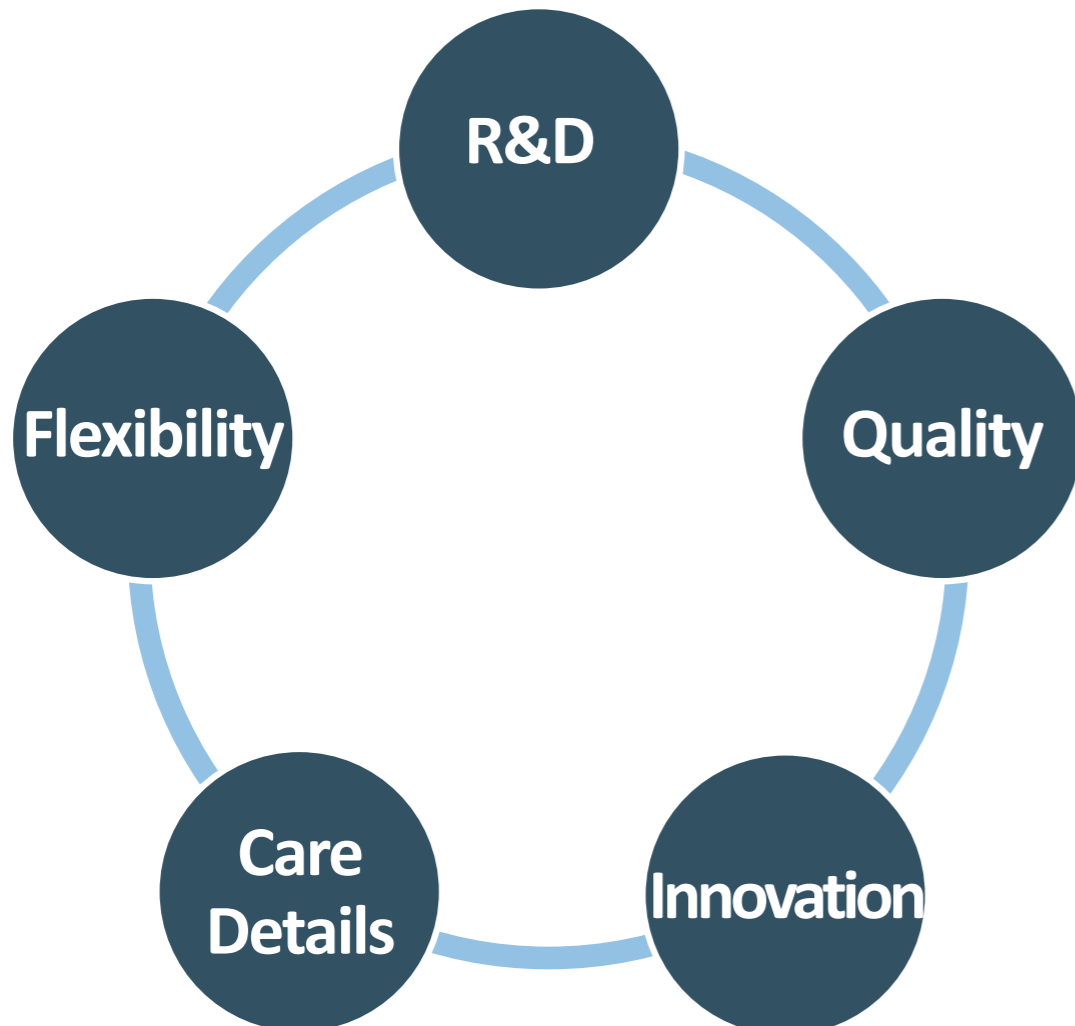

COMPANY CERTIFICATE

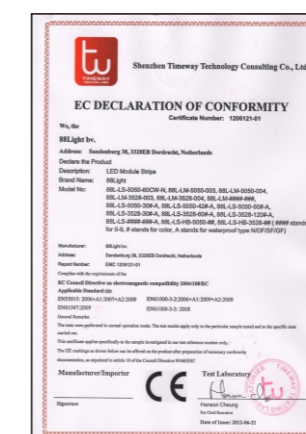
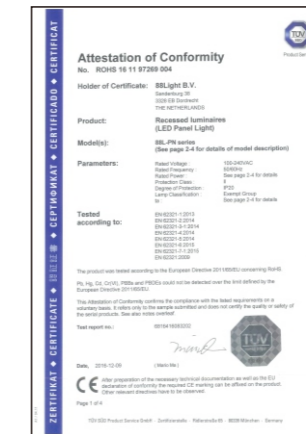



CONTENT

LED Solar Street Lights	01-04
LED Street Lights	05-12
LED HighBay Lights	13-16
LED Flood Lights	17-22
LED Ceiling Lights	23-24
LED Panel Lights	25-26
LED Tube Lights	27-28
LED Down Lights	29-32
LED Strip Lights	33-46
LED Controller	47-56
LED Profile	57-64
LED CornLights	65-68
LED Modules	69-72
LED Decoration Lights	73-76
LED Accessory	77-82
LED Projects	83



LED Solar Street Lights

Scope of Application

- multiple line road
- street walkpads
- collection roads
- motorway
- rural way

Product Features

- All in one design with aluminum alloy material, state of art design, compact in structure, nice in appearance and easy for installation.
- Philips LEDs, 150lm/w higher brightness(Normal solar lamp only 100lm/w).
- New Energy Vehicles Lithium-Iron battery(LiFePO4), 5-8 years lifespan.
- Monocrystalline silicon solar panel, 25 years lifespan with 3 years warranty.
- PIR sensor: 100% brightness if people comes, 30% brightness if without people.
- Back up 3-5 continuous rainy or cloudy days (*Save mode with PIR, Daylight sensor and 8 hours for each day)



88L-SL-1010



Luminous Intensity Distribution Diagram

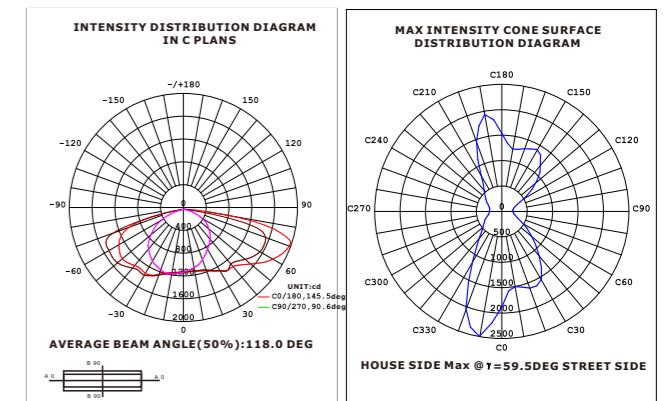

Power	10W	15W	20W	30W	40W	50W	60W	80W
LEDs Brand	PHILIPS							
Flux	1500lm	2250lm	3000lm	4500lm	6000lm	7500lm	9000lm	12000lm
Color temperature	2700K-3200K/Warm White, 4000K-4500K/Neutral White, 6000K-7000K/Cool White							
Color Rendering Index	70							
Battery	Lithium battery							
Battery Capacity	14.6V 6AH	14.6V 10AH	14.6V 14AH	14.6V 20AH	14.6V 26AH	14.6V 34AH	14.6V 40AH	14.6V 56AH
Solar panel	18V 17W	18V 26W	18V 35W	16V 45W	18V 53W	18V 70W	18V 80W	18V 110W
IP Rating	IP65							
Beam Angle	150°							
Material	Aluminium							
Certificate	CE&RoHS							
Lifetime	50,000 hours							
Feature	Motion Sensor Option							
Product Size(mm)	490*327*145	740*327*145	880*327*145	1130*327*145	1260*327*145	1130*453*145	1210*453*145	1360*565*145
Product weight(kg)	6.5	9	12.5	16	18	22	24	27
Pcs/Carton (pcs)	1	1	1	1	1	1	1	1
Carton Size(mm)	580*400*150	795*382*205	950*390*220	1185*390*220	1330*390*220	1190*510*220	1270*510*220	1430*630*220
Carton Weight(kg)	7.5	10.5	14	18	20	24	26	30

88L-SL-1011



Luminous Intensity Distribution Diagram

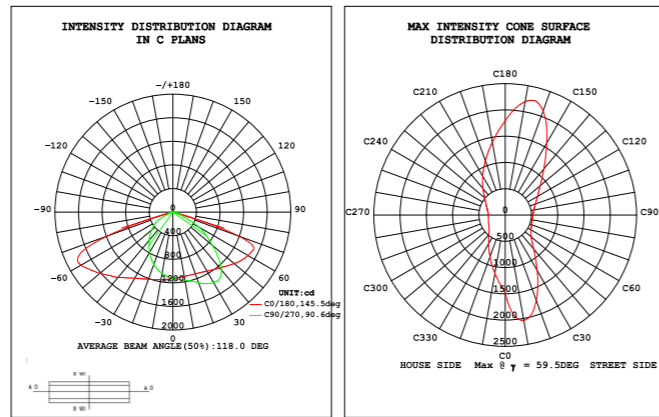

Power	30W	40W	50W	60W	80W	100W
LEDs Brand	BRIDGELUX					
Flux	110 LM/W					
Color temperature	2700K-3200K/Warm White, 4000K-4500K/Neutral White, 6000K-7000K/Cool White					
Color Rendering Index	70					
Battery	Lithium battery					
Battery Capacity	12V 20AH	12V 26AH	12V 34AH	12V 40AH	12V 56AH	24V 34AH
Solar panel	18V 45W	18V 55W	18V 70W	18V 80W	18V 110W	18V 130W
IP Rating	Ip65					
Beam Angle	120°					
Material	Aluminium					
Certificate	CE&RoHS					
Lifetime	50,000 hours					
Feature	Box under Solar Panel/Under Ground Options					
Product Size(mm)	500*220*85	500*220*85	585*220*86	585*220*86	685*220*87	685*220*87
Sets/Cartron	2	2	2	2	2	2
Carton Size(mm)	630*290*290	630*290*290	630*290*290	630*290*290	730*290*290	730*290*290
Carton Weight(kg)	7.88	7.88	9.88	9.88	13.26	13.26

88L-SL-1012



Luminous Intensity Distribution Diagram

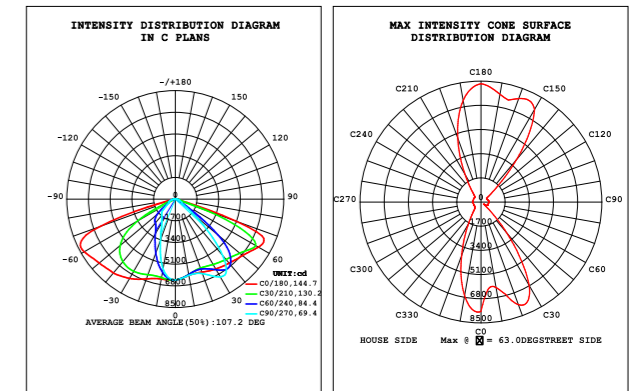

Power	30W	40W	50W	60W	80W	100W
LEDs Brand	PHILIPS					
Flux	110 LM/W					
Color temperature	2700K-3200K/Warm White, 4000K-4500K/Neutral White, 6000K-7000K/Cool White					
Color Rendering Index	70					
Battery	Lithium battery					
Battery Capacity	12V 20AH	12V 26AH	12V 34AH	12V 40AH	12V 56AH	24V 34AH
Solar panel	18V 45W	18V 55W	18V 70W	18V 80W	18V 110W	18V 130W
Power Factor	>0.95					
IP Rating	IP65					
Beam Angle	145*75°					
Material	Aluminium					
Certificate	CE&RoHS					
Lifetime	50000 hours					
Feature	Battery Box under ground/ under solar Panel options					
Product Size(mm)	500*220*85	500*220*85	585*220*86	585*220*86	685*220*87	685*220*87
Inner Box Weight(kg)	2.94	2.94	3.94	3.94	5.63	5.63
Sets/Cartron	2	2	2	2	2	2
Carton Size(mm)	630*290*290	630*290*290	630*290*290	630*290*290	730*290*290	730*290*290
Carton Weight(kg)	7.88	7.88	9.88	9.88	13.26	13.26



88L-SL-1013

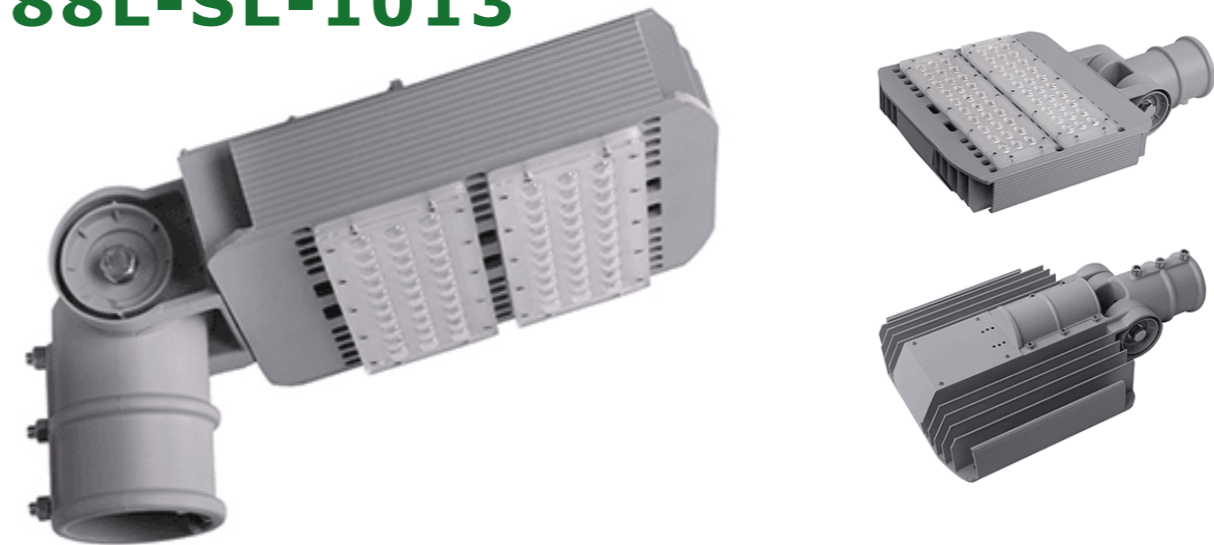

Product Diagram

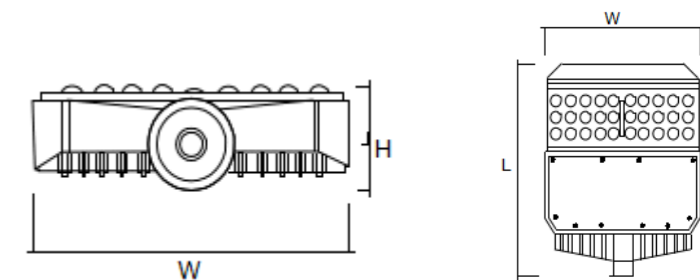

Luminous Intensity Distribution Diagram

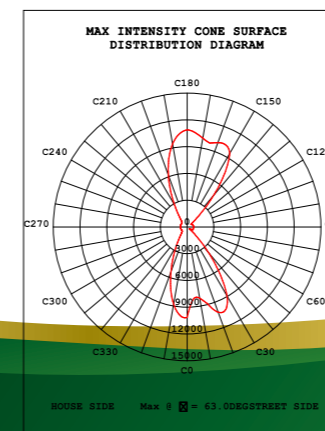
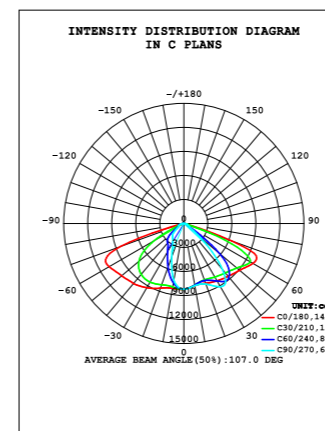

LED Street Lights Product Features

Scope of Application

- multiple line road
- street walkpads
- collection roads
- motorway
- rural way

- State of the art design. Adopt the modern aesthetic streamline design, compact in structure and nice in appearance.
- High color rendering index Philips LED chips(50,000hours lifespan) source light with high-quality.
- Adopt high-quality-high-efficiency constant current MeanWell driver(50,000hours lifespan), to ensure the product's stability, also to reduce the power consumption greatly.
- Low temperatures. Long lifespan more than 50,000 hours.
- IP65 for waterproof.
- No mercury and lead. No UV. No infrared. No radiation. Without causing any flickering, helpful to protect the eyes.
- CE (TUV) for EMC and LVD approved and RoHs compliant.



Power	100W	150W	200W	240W	300W
Input Voltage	AC90-305V 50/60Hz				
LEDs Brand	PHILIPS				
LEDs Quantity	56 pcs	112 pcs	168 pcs	224 pcs	280 pcs
Flux	110 LM/W				
Color temperature	2700K-3200K/Warm White, 4000K-4500K/Neutral White, 6000K-7000K/Cool White				
Color Rendering Index	70				
Driver	Meanwell driver				
Power Factor	>0.9				
IP Rating	IP65				
Beam Angle	140°80°				
Material	Aluminium				
Certificate	CE&RoHS				
Lifetime	50,000 hours				
Feature	Direction adjustable				
Product Size(mm)	437*280*115	526*280*115	615*280*115	704*280*115	793*280*115
Carton Size(mm)	540*340*180	615*340*180	710*340*180	795*340*180	875*340*180
Carton Weight(kg)	6.6	8.4	9.7	10.5	12.8

88L-SL-108



Luminous Intensity Distribution Diagram

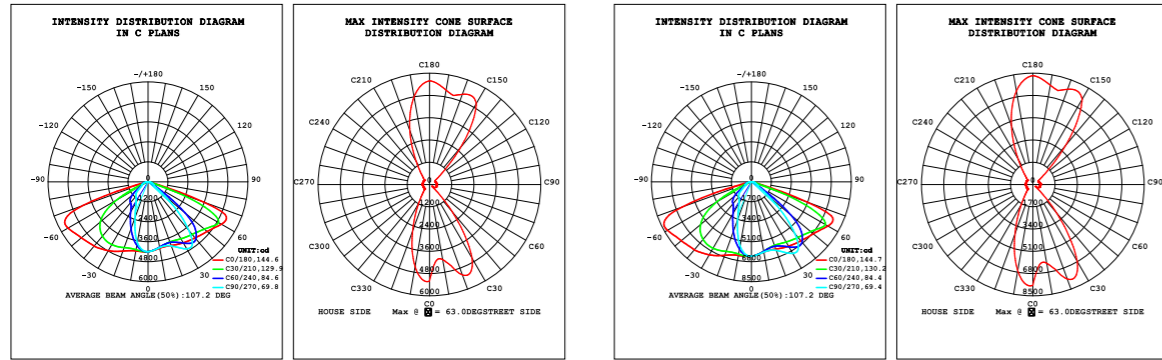

Power	30W	40W	50W	80W	100W	120W	150W	180W	200W	250W
Input Voltage	AC90-305V 50/60Hz									
LEDs Brand	PHILIPS									
Flux	110 LM/W									
Color temperature	2700K-3200K/Warm White, 4000K-4500K/Neutral White, 6000K-7000K/Cool White									
Color Rendering Index	70									
Driver	Meanwell									
Power Factor	>0.9									
IP Rating	IP65									
Beam Angle	120°*90°									
Material	Aluminium									
Certificate	CE&RoHS									
Lifetime	50,000 hours									
Feature	Small volume and light weight									
Product Size(mm)	500*220*85	585*220*86	585*220*86	685*220*87	685*220*87	815*220*88	815*220*88	985*220*89	985*220*89	1131*322*100
Pcs/Carton (pcs)	2	2	2	2	2	1	1	1	1	1
Carton Size(mm)	630*290*290	630*290*290	630*290*290	730*290*290	730*290*290	890*310*160	890*310*160	1010*330*160	1010*330*160	1180*430*170
Carton Weight(kg)	7.88	7.88	9.88	13.26	13.26	9.27	9.27	12	12	15

88L-SL-1014



Luminous Intensity Distribution Diagram

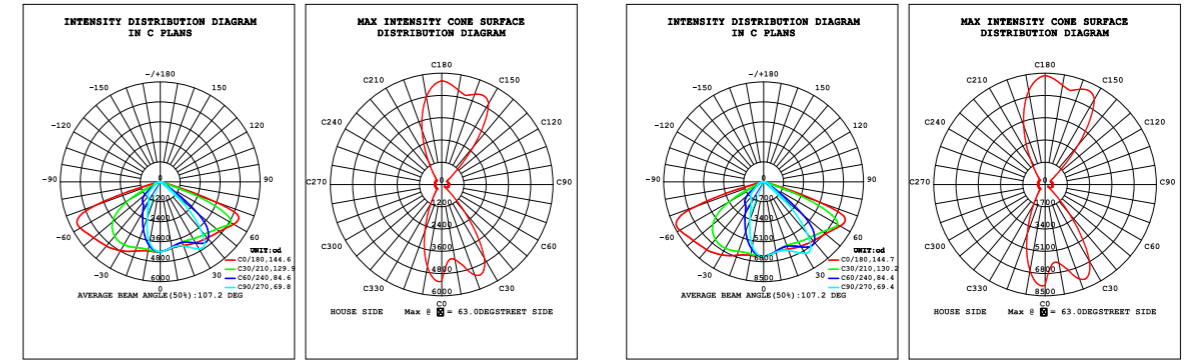

Power	50W	100W	150W	200W	250W	300W
Input Voltage	AC90-305V 50/60Hz					
LEDs Brand	PHILIPS					
LEDs Quantity	50 pcs	100 pcs	150 pcs	200 pcs	250 pcs	300 pcs
Flux	110 LM/W					
Color temperature	2700K-3200K/Warm White, 4000K-4500K/Neutral White, 6000K-7000K/Cool White					
Color Rendering Index	70					
Driver	Meanwell					
Power Factor	>0.9					
IP Rating	IP65					
Beam Angle	120°*90°					
Material	Aluminium					
Certificate	CE&RoHS					
Lifetime	50,000 hours					
Feature	Modular Design					
Product Size(mm)	205*305*60	315*305*60	425*305*60	535*305*60	645*305*60	755*305*60
Carton Size(mm)	330*370*160	430*370*160	540*370*160	610*370*160	720*370*160	800*370*160
Carton Weight(kg)	5.5	7.15	9.3	10.95	12.1	14.75

88L-SL-109



Luminous Intensity Distribution Diagram

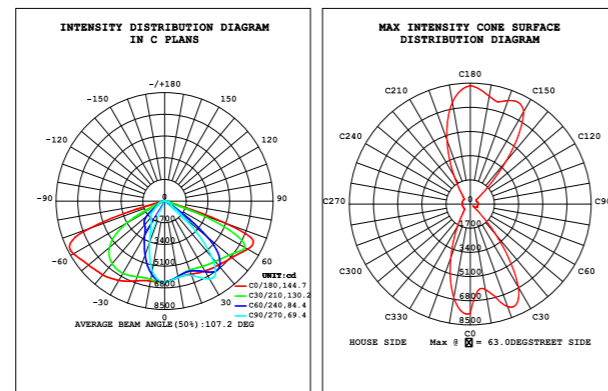

Power	30W	40W	60W	90W	120W	150W
Input Voltage	AC90-305V 50/60Hz					
LEDs Brand	PHILIPS					
LEDs Quantity	24 pcs	36 pcs	54 pcs	77 pcs	112 pcs	144 pcs
Flux	110 LM/W					
Color temperature	2700K-3200K/Warm White, 4000K-4500K/Neutral White, 6000K-7000K/Cool White					
Color Rendering Index	70					
Driver	Meanwell					
Power Factor	>0.9					
IP Rating	IP65					
Beam Angle	145°*75°					
Material	Aluminium					
Certificate	CE&RoHS					
Lifetime	50,000 hours					
Feature	Direction Adjustable					
Product Size(mm)	365.8*135*84.4	365.8*135*89.3	431.3*160*89.3	431.3*160*89.3	631.7*215*89.8	631.7*215*89.8
Carton Size(mm)	415*190*145	415*190*145	475*215*145	475*215*145	685*270*145	685*270*145
Carton Weight(kg)	2.35	2.4	2.67	4.16	4.28	5.9

88L-SL-1018

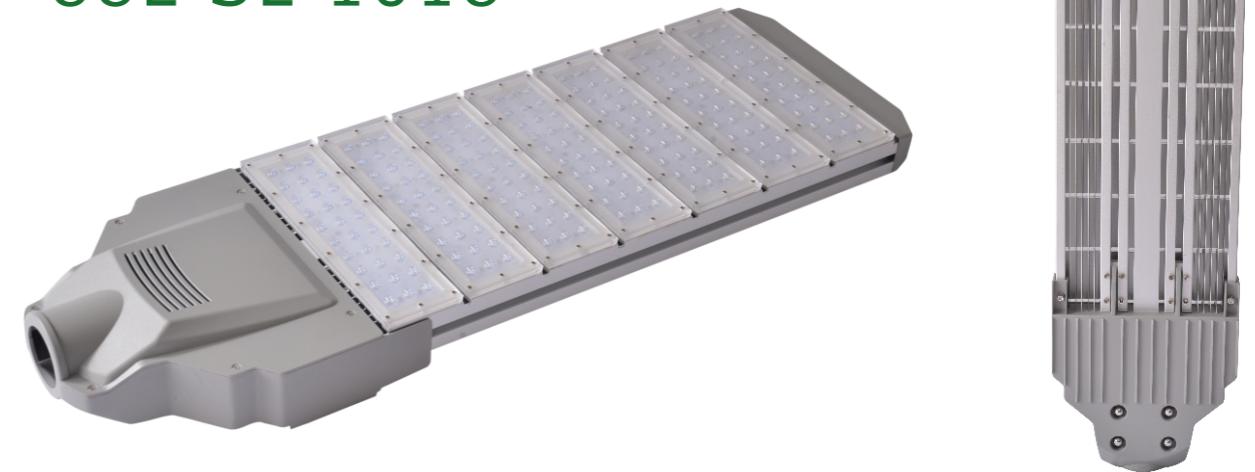

Luminous Intensity Distribution Diagram

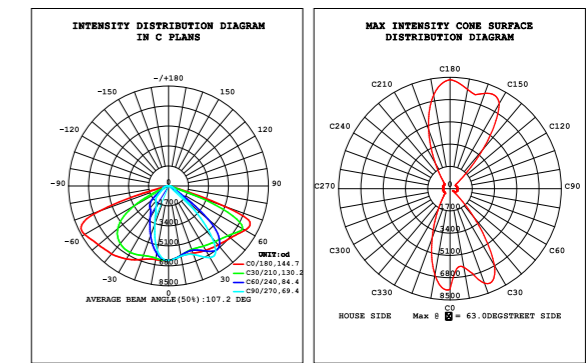

Power	50W	100W	150W	200W	250W	300W
Input Voltage	AC90-305V 50/60Hz					
LEDs Brand	PHILIPS					
LEDs Quantity	50 pcs	100 pcs	150 pcs	200 pcs	250 pcs	300 pcs
Flux	110 LM/W					
Color temperature	2700K-3200K/Warm White, 4000K-4500K/Neutral White, 6000K-7000K/Cool White					
Color Rendering Index	70					
Driver	Meanwell					
Power Factor	>0.9					
IP Rating	IP65					
Beam Angle	120°*90°					
Material	Aluminium					
Certificate	CE&RoHS					
Lifetime	50,000 hours					
Feature	Modular Design					
Product Size(mm)	480*305*110	610*305*110	750*305*110	890*305*110	1030*305*110	1170*305*110
Carton Size(mm)	540*370*150	720*370*150	800*370*150	960*370*150	1260*370*150	1260*370*150
Carton Weight(kg)	7.3	9.3	11.9	14	15.6	18.7

88L-SL-1015

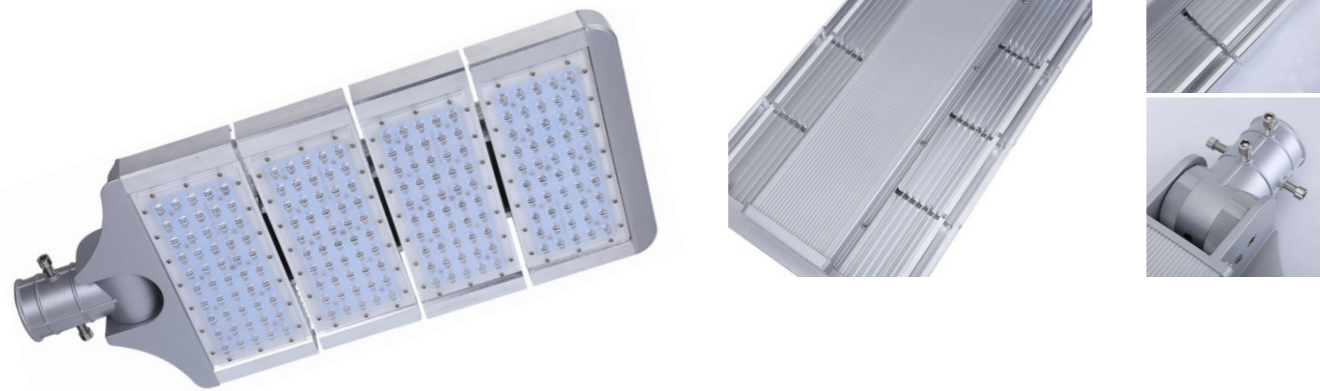

Product Diagram

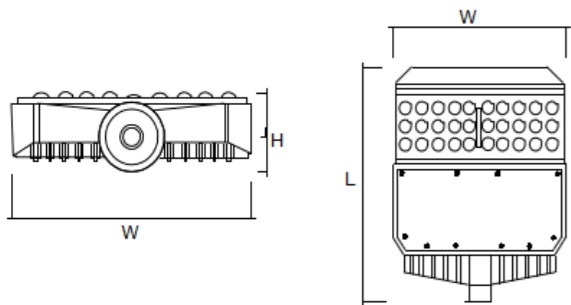

Luminous Intensity Distribution Diagram

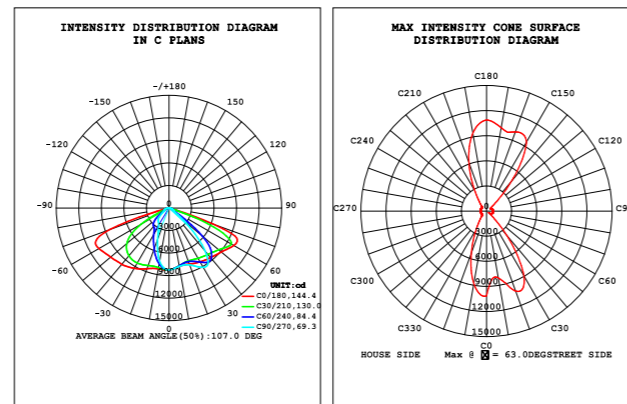

Power	50W	100W	150W	200W	250W	300W
Input Voltage	AC90-305V 50/60Hz					
LEDs Brand	PHILIPS					
LEDs Quantity	48 pcs	96 pcs	144 pcs	192 pcs	240 pcs	288 pcs
Flux	110 LM/W					
Color temperature	2700K-3200K/Warm White, 4000K-4500K/Neutral White, 6000K-7000K/Cool White					
Color Rendering Index	70					
Driver	Meanwell					
Power Factor	> 0.9					
IP Rating	IP65					
Beam Angle	120°*90°					
Material	Aluminium					
Certificate	CE&RoHS					
Lifetime	50,000 hours					
Feature	Modular Design					
Product Size(mm)	320*310*90	446*310*90	572*310*90	698*310*90	824*310*90	950*310*90
Carton Size(mm)	340*320*110	470*320*110	610*320*110	710*320*110	840*320*110	960*320*110
Carton Weight(kg)	6.05	7.83	6.11	11.39	13.17	15.95

88L-SL-1019



Luminous Intensity Distribution Diagram

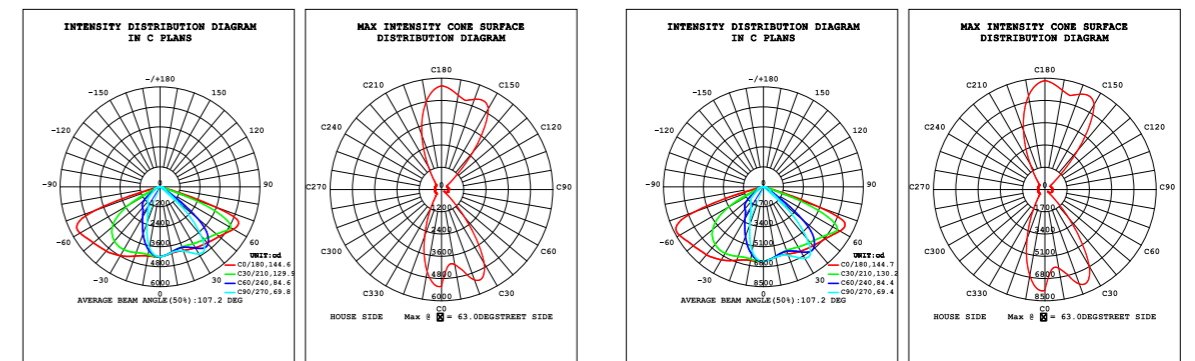

Power	60W	120W	180W	240W
Input Voltage	AC90-305V 50/60Hz			
LEDs Brand	PHILIPS			
LEDs Quantity	64 pcs	128 pcs	192 pcs	288 pcs
Flux	110 LM/W			
Color temperature	2700K-3200K/Warm White, 4000K-4500K/Neutral White, 6000K-7000K/Cool White			
Color Rendering Index	70			
Driver	Meanwell driver Meanwell driver			
Power Factor	> 0.9			
IP Rating	IP65			
Beam Angle	120°*90°			
Material	Aluminium			
Certificate	CE&RoHS			
Lifetime	50,000 hours			
Feature	Integrated Design			
Product Size(mm)	422*320*140	522*320*140	600*320*140	850*320*140
Carton Size(mm)	430*390*240	630*390*240	710*390*240	960*390*240
Carton Weight(kg)	7.5	10.5	12.5	15



LED Highbay Light

Scope of Application

- Warehouse
- workshop, parking lot
- large supermarket
- Exhibition hall
- Gymnasium and other lighting places

Product Features

- Aircraft-grade aluminium housing, Meanwell driver, better heat dissipation.
- Sealed glue irrigation assure high IP65, more than 50,000 hours lifetime.
- Radiator cavity in eddy current type, philips chips.
- CCT 2700-7000K.
- Hanging to install, different beam angle with high transmissions.
- Cooling system formed by copper plate, pure aluminum radiator, perfect cooling function.

88L-HB-108



Product Diagram

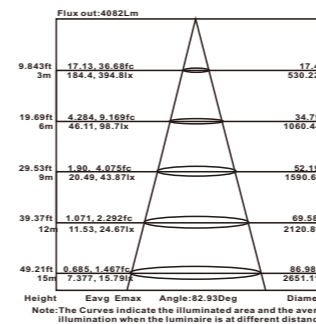

Luminous Intensity Distribution Diagram

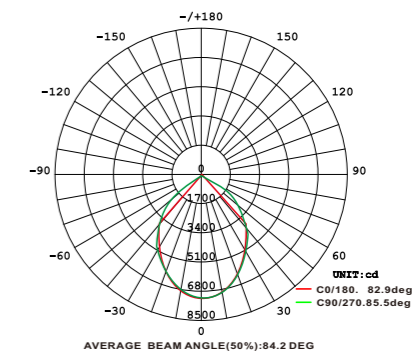

Power	60W	80W	100W	150W	200W	250W	300W
LEDs Quantity	63 pcs	105 pcs	105 pcs	154 pcs	203 pcs	252 pcs	300 pcs
Color temperature	2700K-3200K/Warm White, 4000K-4500K/Neutral White, 6000K-7000K/Cool White						
Input Voltage	AC90-305V						
LEDs Brand	PHILIPS						
Flux	110 LM/W						
Color Rendering Index	70						
Driver	Meanwell driver						
Power Factor	> 0.9						
Total Harmonic Index	< 20%						
Operation Temperature	-30°C ~50°C						
IP Rating	IP65						
Beam Angle	45°/90°/120°						
Material	Aluminium						
Certificate	CE&RoHS						
Lifetime	50,000 hours						
Feature	SMD Light Source						
Product Size(mm)	258*182	258*182	295*182	335*182	350*226	329*284	369*284
Carton Size(mm)	190*190*350	190*190*350	190*190*390	190*190*430	255*255*435	300*300*360	300*300*380
Carton Weight(kg)	3.7	3.75	4.1	5	6	8.8	9
Pcs/Carton (pcs)	1	1	1	1	1	1	1



88L-HB-105

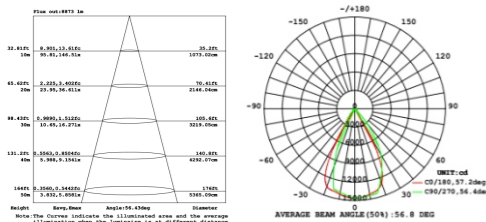

Power	100W	150W	200W
Input Voltage	AC90-305V		
LEDs Brand	PHILIPS		
LEDs Quantity	120 pcs	196 pcs	266 pcs
Flux	110 LM/W		
Color temperature	2700K-3200K/Warm White, 4000K-4500K/Neutral White, 6000K-7000K/Cool White		
Color Rendering Index	70		
Driver	Meanwell driver		
Power Factor	> 0.9		
Total Harmonic Index	< 20%		
Operation Temperature	-30°C ~ 50°C		
IP Rating	IP65		
Beam Angle	60°/90°		
Material	Aluminium		
Certificate	CE&RoHS		
Lifetime	50,000 hours		
Feature	UFO shape Small volume		
Product Size(mm)	Φ 321*140	Φ 383*168	Φ 420*220
Carton Size(mm)	380*380*200	440*440*230	440*440*170
Carton Weight(kg)	4.9	5.7	7
Pcs/Carton (pcs)	1	1	1

Power	50W	100W	150W	200W
Input Voltage	AC90-295V	AC90-305V		
LEDs Brand	PHILIPS			
LEDs Quantity	63 pcs	120 pcs	196 pcs	266 pcs
Flux	110 LM/W			
Color temperature	2700K-3200K/Warm White, 4000K-4500K/Neutral White, 6000K-7000K/Cool White			
Color Rendering Index	70			
Driver	Meanwell driver			
Power Factor	> 0.9			
Total Harmonic Index	< 20%			
Operation Temperature	-30°C ~ 50°C			
IP Rating	IP20			
Beam Angle	25°/60°/100°			
Material	Aluminium			
Certificate	CE&RoHS			
Lifetime	50,000 hours			
Feature	Small Body Small volume			
Product Size(mm)	210*165	210*185	210*215	210*265
Carton Size(mm)	260*260*210	260*260*230	260*260*260	260*260*300
Carton Weight(kg)	3.6	4.5	4.9	5.7
Pcs/Carton (pcs)	1	1	1	1
25° Reflector pcs/carton	15			
25° Reflector carton weight	2.4 kg			
25° Reflector carton size	280*280*200			
60° Reflector pcs/carton	15			
60° Reflector carton weight	4.3 kg			
60° Reflector carton size	360*360*220			
100° Reflector pcs/carton	20			
100° Reflector carton weight	5.6 kg			
100° Reflector carton size	360*360*220			

88L-HB-109



88L-HB-106



Product Diagram

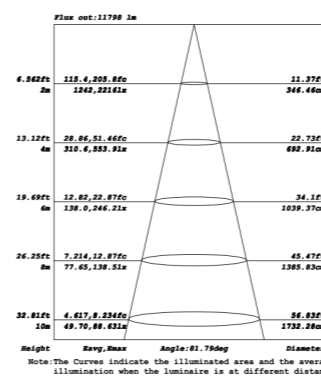

Luminous Intensity Distribution Diagram

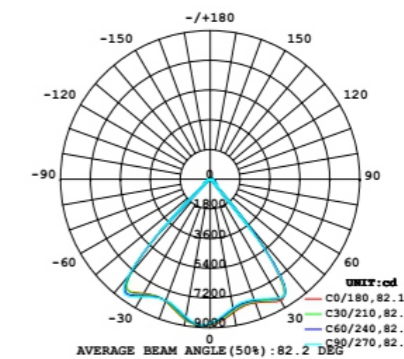

Power	60W	100W	150W	200W	250W	300W	400W	500W
LEDs Quantity	56 pcs	112 pcs	168 pcs	224 pcs	280 pcs	336 pcs	448 pcs	560 pcs
Color temperature	2700K-3200K/Warm White, 4000K-4500K/Neutral White, 6000K-7000K/Cool White							
Input Voltage	AC90-305V							
LEDs Brand	PHILIPS							
Flux	110 LM/W							
Color Rendering Index	70							
Driver	Meanwell driver							
Power Factor	> 0.9							
Total Harmonic Index	< 20%							
Operation Temperature	-30°C ~ 50°C							
IP Rating	Ip20							
Beam Angle	60°*60°/30°*80°							
Material	Aluminium							
Certificate	CE&RoHS							
Lifetime	50,000 hours							
Feature	Linear Shape							
Product Size(mm)	353*115*144	620*115*144	887*115*144	1154*115*144	1421*115*144	947*230*173	1214*230*173	1481*230*173
Carton Size(mm)	385*165*195	650*165*195	920*165*195	1185*165*195	1450*165*195	970*280*220	1240*280*220	1505*280*220
Carton Weight(kg)	3.15	4.75	5.55	7	7.95	11.6	13.5	15.4
Pcs/Carton (pcs)	1	1	1	1	1	1	1	1



LED Flood Light

Scope of Application

- Warehouse
- workshop, parking lot
- large supermarket
- Exhibition hall
- Gymnasium and other lighting places

Product Features

- Aircraft-grade aluminium housing, Meanwell driver, better heat dissipation.
- Sealed glue irrigation assure high IP65, more than 50,000 hours lifetime.
- Radiator cavity in eddy current type, philips chips.
- CCT 2700-7000K.
- Hanging to install, different beam angle with high transmissions.
- Cooling system formed by copper plate, pure aluminum radiator, perfect cooling function.



88L-FL-103

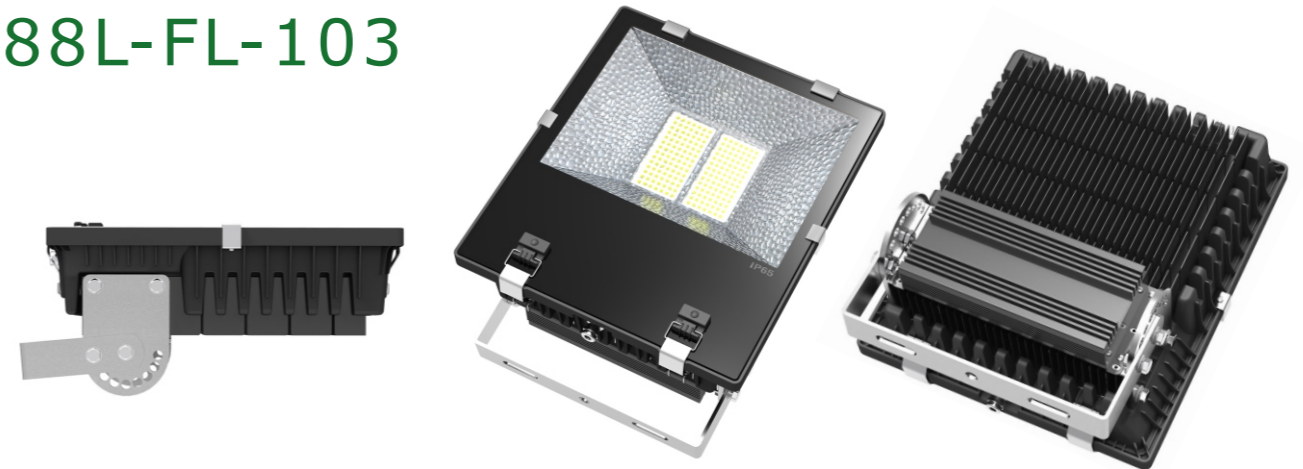

Product Diagram

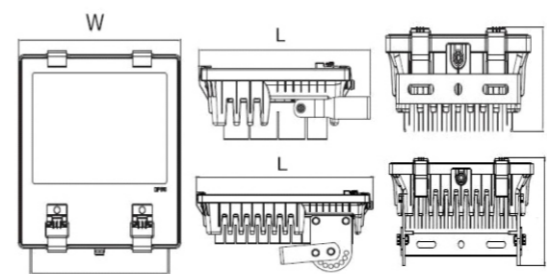

Luminous Intensity Distribution Diagram

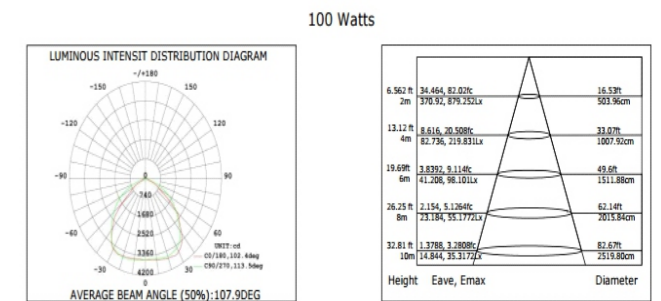

Power	100W	120W	150W	200W
Input Voltage	AC90-305V			
LEDs Brand	PHILIPS			
LEDs Quantity	108 pcs	120 pcs	168 pcs	210 pcs
Flux	110 LM/W			
Color temperature	2700K-3200K/Warm White, 4000K-4500K/Neutral White, 6000K-7000K/Cool White/R/G/B/RGB/			
Color Rendering Index	70			
Driver	Meanwell driver			
Power Factor	> 0.9			
Total Harmonic Index	< 20%			
IP Rating	IP65			
Beam Angle	120°			
Material	Aluminium			
Certificate	CE&RoHS			
Lifetime	50,000 hours			
Feature	SMD Chip Intergrated Body			
Product Size(mm)	341*250*116	315*310*187	375*310*187	400*340*192
Inner Box Size(mm)	395*345*240	405*405*265	460*405*265	470*420*260
Inner Box Weight(kg)	7	8.95	9.8	11.35
Pcs/Carton (pcs)	4	2	2	2
Carton Size(mm)	730*420*545	430*430*600	485*430*600	490*440*575
Carton Weight(kg)	30	19.9	21.6	24.7

88L-FL-105



Product Diagram

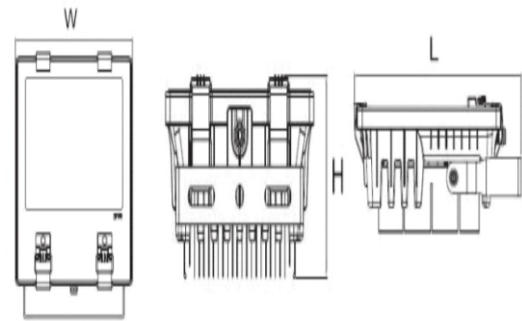

Luminous Intensity Distribution Diagram

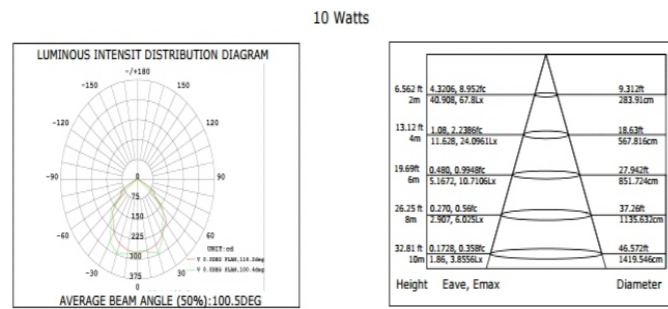

Power	10W	20W	30W	50W	70W	100W	150W	200W
LEDs Quantity	20 pcs	40 pcs	60 pcs	100 pcs	140 pcs	200 pcs	300 pcs	400 pcs
Color temperature	2700K-3200K/Warm White, 4000K-4500K/Neutral White, 6000K-7000K/Cool White							
Input Voltage	AC85-265V							
LEDs Brand	EPISTAR							
Flux	100 LM/W							
Color Rendering Index	70							
Driver	Normal CE							
Power Factor	> 0.9							
Total Harmonic Index	< 20%							
IP Rating	IP65							
Beam Angle	120°							
Material	Aluminium							
Certificate	CE&RoHS							
Lifetime	50,000 hours							
Feature	SMD Chips with intergrated body							
Product Size(mm)	135*115*40	180*140*40	225*185*45	285*225*50	290*290*70	290*290*70	335*315*97	373*373*125
Inner Box Size(mm)	190*190*350	190*190*350	190*190*390	190*190*430	255*255*435	300*300*360	350*325*100	300*300*380
Inner Box Weight(kg)	0.55	1.21	1.3	2	3.2	5.4	7.5	10.7
Pcs/Carton (pcs)	50	20	15	10	5	5	1	1
Carton Size(mm)	650*270*325	780*285*220	71*330*270	765*330*305	400*307*405	40*307*405	390*370*162	430*430*190
Carton Weight(kg)	30	23.21	28	22	18	29	9.5	13.2

88L-FL-108



Product Diagram

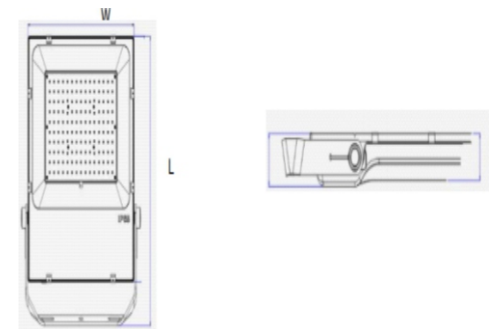

Luminous Intensity Distribution Diagram

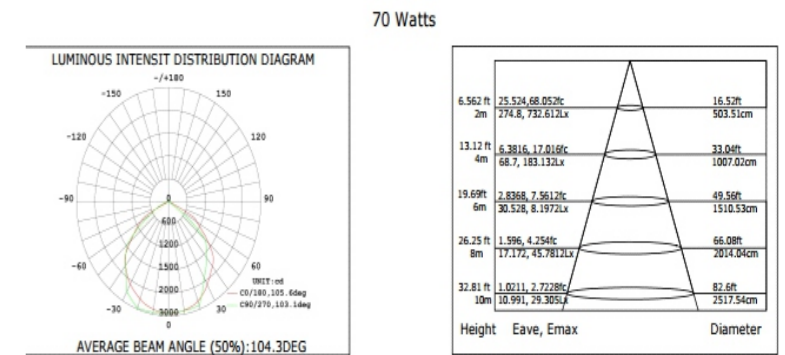

Power	70W	100W	150W	200W
Input Voltage	AC90-305V			
LEDs Brand	PHILIPS			
LEDs Quantity	80 pcs	105 pcs	154 pcs	240 pcs
Flux	110 LM/W			
Color temperature	2700K-3200K/Warm White, 4000K-4500K/Neutral White, 6000K-7000K/Cool White			
Color Rendering Index	70			
Driver	Meanwell driver			
Power Factor	> 0.9			
Total Harmonic Index	< 20%			
IP Rating	IP65			
Beam Angle	120°			
Material	Aluminium			
Certificate	CE&RoHS			
Lifetime	50,000 hours			
Feature	SMD Chips with intergrated Body			
Product Size(mm)	354.5*245*55	402.5*295*60	430.5*330*60	470.5*360*60
Inner Box Size(mm)	435*340*13	480*390*135	510*435*135	555*460*135
Inner Box Weight(kg)	3.91	5.22	6.12	7.46
Pcs/Carton (pcs)	6	6	4	4
Carton Size(mm)	455*355*850	500*405*880	530*450*590	575*475*590
Carton Weight(kg)	25.46	33.32	26.48	31.84

88L-FL-106



Product Diagram

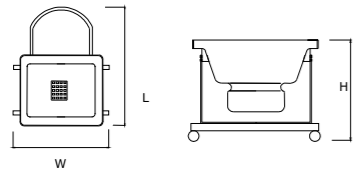

Luminous Intensity Distribution Diagram

20 Watts

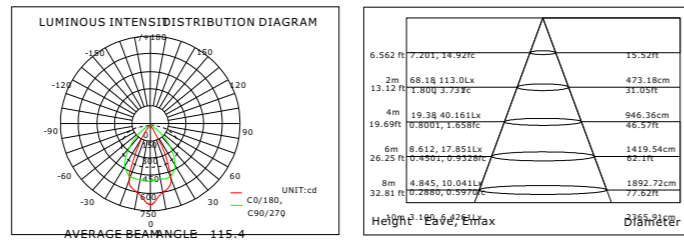

Power	5W	10W	20W
LEDs Quantity	1pcs COB	1pcs COB	1pcs COB
Color temperature	2700K-3200K/Warm White, 4000K-4500K/Neutral White, 6000K-7000K/Cool White		
Input Voltage	Charger Input Voltage AC85-265V		
LEDs Brand	Epistar		
Flux	85LM/W		
Color Rendering Index	70		
Driver	Adapter		
Power Factor	> 0.9		
Total Harmonic Index	< 20%		
IP Rating	IP65		
Beam Angle	120°		
Material	Aluminium		
Certificate	CE&RoHS		
Lifetime	50,000 hours		
Feature	Battery inside Chargeable Portable		
Product Size(mm)	L225xW165xH135	L225xW165xH135	L225xW220xH150
Inner Box Size(mm)	230x170x140	230x170x140	230x135x160
Inner Box Weight(kg)	1.9	1.9	2.25
Pcs/Carton (pcs)	16	16	12
Carton Size(mm)	425x515x465	425x515x465	470x525x455
Carton Weight(kg)	32	32	30

88L-HB-104

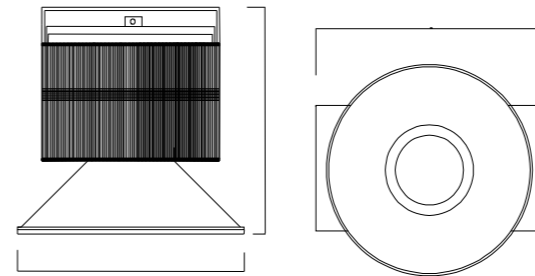

400 Watts

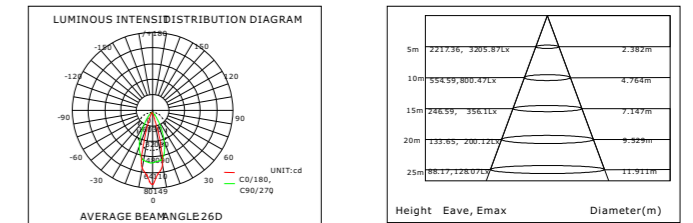

Power	120W	150W	200W	300W	400W	500W	1000W
Input Voltage	AC90-305V						
LEDs Brand	PHILIPS						
LEDs Quantity	120 pcs	150 pcs	210 pcs	320 pcs	400 pcs	480 pcs	504 pcs
Flux	110 LM/W						
Color temperature	2700K-3200K/Warm White, 4000K-4500K/Neutral White, 6000K-7000K/Cool White						
Color Rendering Index	70						
Driver	Meanwell						
Power Factor	> 0.9						
Total Harmonic Index	< 20%						
IP Rating	IP65						
Beam Angle	120°						
Material	Aluminium						
Certificate	CE&RoHS						
Lifetime	50,000 hours						
Feature	Small volume High Power						
Product Size(mm)	332*270*456	332*270*456	268*270*456	328*270*486	328*323*516	385*323*516	450*630
Carton Size(mm)	460*460*540	460*460*540	460*460*540	460*460*540	460*460*540	460*460*540	630*545*570
Carton Weight(kg)	10	10.7	10.8	13.1	14.8	15.6	33
Pcs/Carton (pcs)	1	1	1	1	1	1	1



88L-CL-102

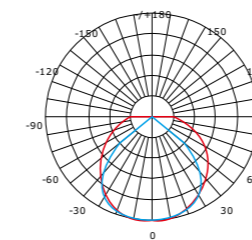
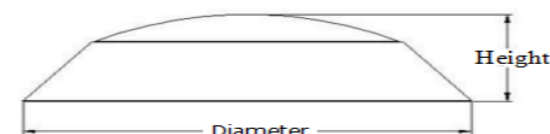

Power	12W	18W
Input Voltage	AC100-240V 50/60Hz	
LEDs Brand	EPISTAR	
LEDs Quantity	24pcs	36 pcs
Flux	1200 LM	1800 LM
Color temperature	2700K-3200K/Warm White, 4000K-4500K/Neutral White, 6000K-7000K/Cool White	
Color Rendering Index	80	
Driver	CE driver	
Power Factor	> 0.6	
Total Harmonic Index	< 20%	
Operation Temperature	-30°C ~ 50°C	
IP Rating	IP20	
Beam Angle	120°*120°	
Material	PC	
Certificate	CE&RoHS	
Lifetime	50,000 hours	
Feature	Uniform light	
Product Size(mm)	260*110	330*110
Inner Box Size(mm)	300*120*300	370*120*370
Inner Box Weight(kg)	1.2	1.5
Pcs/Carton (pcs)	10	10
Carton Size(mm)	530*310*620	580*385*760
Carton Weight(kg)	14	18

88L-CL-101



Power	12W	18W
Input Voltage	AC90-264V 50/60Hz	
LEDs Brand	EPISTAR	
LEDs Quantity	24pcs	36 pcs
Flux	1200 LM	1800 LM
Color temperature	2700K-3200K/Warm White, 4000K-4500K/Neutral White, 6000K-7000K/Cool White	
Color Rendering Index	80	
Driver	CE driver	
Power Factor	> 0.6	
Total Harmonic Index	< 20%	
Operation Temperature	-30°C ~ 50°C	
IP Rating	IP65	
Beam Angle	120°*120°	
Material	Aluminum	
Certificate	CE&RoHS	
Lifetime	50,000 hours	
Feature	Artistic design	
Product Size(mm)	Φ 295*H110	Φ 360*H110
Inner Box Size(mm)	300*120*300	370*120*370
Inner Box Weight(kg)	1	1.3
Pcs/Carton (pcs)	10	10
Carton Size(mm)	530*310*620	580*385*760
Carton Weight(kg)	12	15

LED Ceiling Lights

Scope of Application

Warehouse
workshop, parking lot
large supermarket
Exhibition hall
Gymnasium and other lighting places

Product Features

- IP20 Waterproof.
- Very convenient to installation.
- Good heat dissipation performance guarantee the long life span.
- High effective energy-saving and environmental-friendly.
- Power factor ≥ 0.9 . Adopt high-quality-high-efficiency constant current driver, to ensure the product's stability, also to reduce the power consumption greatly.
- Long lifespan more than 50,000hours.
- No mercury and lead. No UV. No infrared. No radiation. Without causing any flickering, helpful to protect the eyes.
- CE (TUV) for EMC and LVD approved and RoHS compliant.





LED Panel Lights

Scope of Application

Airport, Bathroom
 Bathroom Room, Bedroom, Car Park
 Church, Cinema, Gallery, Garage, Hospital
 Hotel, Kitchen, Meeting Room, Museum
 Office, Restaurant, School
 Shopping Mall and other lighting places.

Product Features

- High brightness SMD LED Chips, 120lm/w for finished products.
- High quality 6063 aluminum ally frame, good heat dissipation, strong hardnes, Anodic oxidation and white paint.
- Power factor ≥ 0.9 . Adopt high-quality-high-efficiency constant current driver, to ensure the product's stability, also to reduce the power consumption greatly.
- Long lifespan more than 50,000hours.
- No mercury and lead. No UV. No infrared. No radiation. Without causing any flickering, helpful to protect the eyes.
- CE (TUV) for EMC and LVD approved and RoHS compliant.



88L-PN



40 Watts Normal Q600 Panel Light

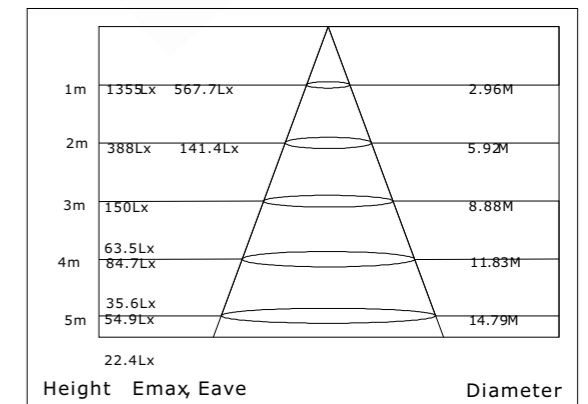
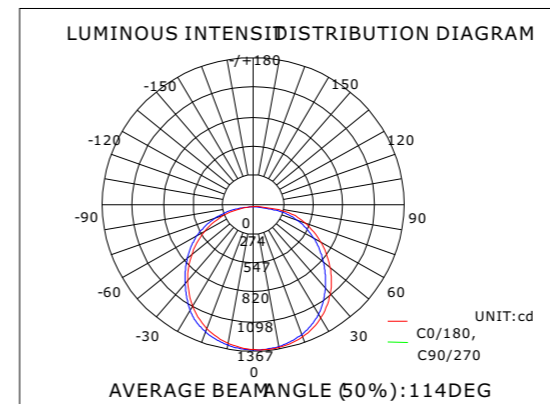

Power	12W	24W	40W	48W	60W
Input Voltage	AC100-240V 50/60Hz				
LEDs Brand	EPISTAR				
LEDs Quantity	60 pcs	120 pcs	216 pcs	240 pcs	360 pcs
Flux	1440 LM/W	2880 LM	4800LM	5760 LM	7200 LM
Color temperature	2700K-3200K/Warm White, 4000K-4500K/Neutral White, 6000K-7000K/Cool White, CCT / RGBW / RGB				
Color Rendering Index	80				
Driver	CE&RoHS				
Power Factor	> 0.9				
Total Harmonic Index	< 20%				
Operation Temperature	-30°C ~ 50°C				
IP Rating	IP40				
Beam Angle	120°				
Material	Aluminium				
Certificate	CE&RoHS				
Lifetime	50,000 hours				
Feature	UGR<19 / Normal Options				
Product Size(mm)	300*300*9	300*600*9	600*600*9	300*1200*9	300*1200*9
Inner Box Size(mm)	320*360*32	630*350*35	1270*35*320	630*650*35	1225*27*620
Inner Box Weight(kg)	0.98	2.08	3.8	4.16	6
Pcs/Carton (pcs)	20	5	5	5	2
Carton Size(mm)	660*335*375	647*190*335	1287*190*340	647*190*670	1315*75*640
Carton Weight(kg)	21	12	21	22.8	13



LED Tri-Proof Lights

Scope of Application

Hotels & schools
Hospitals & shopping mall, Factories
offices & meeting rooms and other lighting places.

Product Features

- IP65 Water-proof, Dust-proof and Corrosion-proof.
- Rational Linear design.
- Power factor ≥ 0.9 . Adopt high-quality-high-efficiency constant current driver, to ensure the product's stability, also to reduce the power consumption greatly.
- Long lifespan more than 50,000hours.
- No mercury and lead. No UV. No infrared. No radiation. Without causing any flickering, helpful to protect the eyes.
- CE (TUV) for EMC and LVD approved and RoHS compliant.

88L-LT

18 Watts

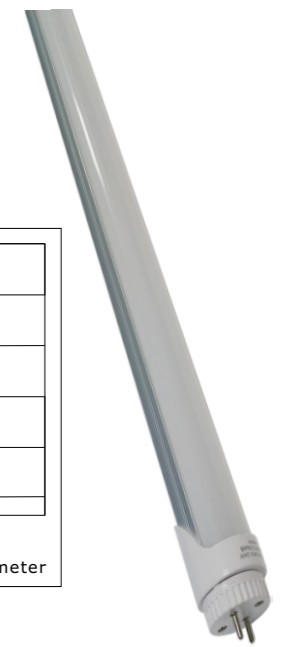
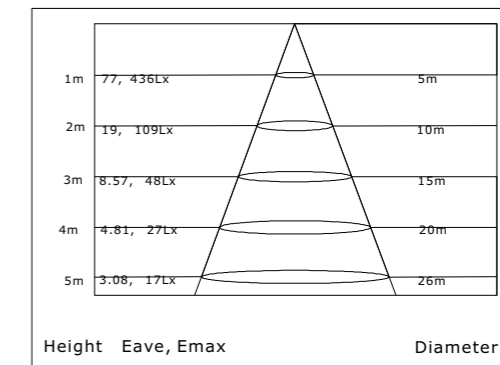
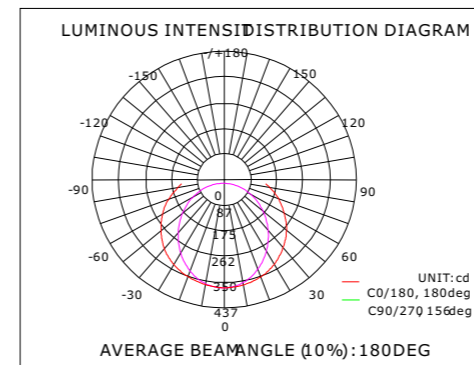

Power	10W	14W	18W	24W	38W
Input Voltage	AC85-165V 50/60Hz AC165-265V 50/60Hz				
LEDs Brand	3014LED with Epistar inside				
LEDs Quantity	120 pcs	126 pcs	192 pcs	220 pcs	240 pcs
Flux	1100 LM	1500 LM	1800 LM	2600 LM	3800 LM
Color temperature	2700K-3200K/Warm White, 4000K-4500K/Neutral White, 6000K-7000K/Cool White				
Color Rendering Index	80				
Driver	Isolated-Constant Current Driver				
Power Factor	0.9				
Special Color	Red/Green/Blue/Pink				
Operation Temperature	-25°C ~ 45°C				
IP Rating	IP44				
Beam Angle	120°				
Material	Aluminium&PC				
Certificate	CE&RoHS				
Lifetime	50,000 hours				
Feature	Rotatable/Non-Rotatable				
Product Size(mm)	L600xD26	L900xD26	L1200xD26	L1500xD26	L2400xD26
Inner Box Size(mm)	650x40	950x40	1250x40	1550x40	2450x40
Inner Box Weight(kg)	0.21	0.32	0.44	0.54	0.9
Pcs/Carton (pcs)	25	25	25	25	25
Carton Size(mm)	680x220x220	980x220x220	1300x220x220	1590x220x220	2490x220x220
Carton Weight(kg)	6.6	9.6	12.6	15	25





LED Down Lights

Scope of Application

Airport, Bathroom
 Bathroom Room, Bedroom, Car Park
 Church, Cinema, Gallery, Garage, Hospital
 Hotel, Kitchen, Meeting Room, Museum
 Office, Restaurant, School, Shopping Mall
 Sitting Room and other lighting places.

Product Features

- COB Chips, super brightness, high Lumen 100lm/w.
- Superior die-casting aluminium, Perfect heat dissipation.
- Separation design, Light source could be replaced.
- Innovation design of removable wick, More flexible application.
- Power factor ≥ 0.9 . Adopt high-quality-high-efficiency constant current driver, to ensure the product's stability, also to reduce the power consumption greatly.
- Long lifespan more than 50,000hours.
- No mercury and lead. No UV. No infrared. No radiation. Without causing any flickering, helpful to protect the eyes.
- CE (TUV) for EMC and LVD approved and RoHS compliant.



88L-DL-101



Power	9W	15W	20W	30W	40W	60W
Input Voltage	AC100-240V 50/60Hz					
LEDs Brand	EPISTAR					
LEDs Quantity	1 pcs	1 pcs	1 pcs	1 pcs	1 pcs	1 pcs
Flux	900 LM	1500 LM	2000 LM	3000 LM	4000 LM	6000 LM
Color temperature	2700K-3200K/Warm White, 4000K-4500K/Neutral White, 6000K-7000K/Cool White					
Color Rendering Index	80					
Driver	CE&RoHS					
Power Factor	> 0.9					
Total Harmonic Index	< 20%					
Operation Temperature	-30°C ~ 50°C					
IP Rating	IP20					
Beam Angle	60°					
Material	Aluminium					
Certificate	CE&RoHS					
Lifetime	50,000 hours					
Feature	Intergrated design					
Product Size(mm)	108*108*52	142*142*65	158*158*75	185*185*88	226*226*108	282*282*130
Hole size(mm)	95	125	140	170	210	265
Pcs/Carton (pcs)	50	30	30	30	8	4
Carton Size(mm)	590*250*350	460*310*745	510*350*450	400*400*520	480*480*260	590*590*310
Carton Weight(kg)	19.4	20.86	25.9	33.73	15.31	13.18

88L-DL-102



Power	7W	12W	18W	25W	30W	40W
Input Voltage	AC100-240V 50/60Hz					
LEDs Brand	PHILIPS					
LEDs Quantity	9	12	24	36	48	60
Flux	700 LM	1200 LM	1800 LM	2500 LM	3000 LM	4000 LM
Color temperature	2700K-3200K/Warm White, 4000K-4500K/Neutral White, 6000K-7000K/Cool White					
Color Rendering Index	80					
Driver	CE&RoHS					
Power Factor	> 0.9					
Total Harmonic Index	< 20%					
Operation Temperature	-30°C ~ 50°C					
IP Rating	IP20					
Beam Angle	120°					
Material	Aluminium					
Certificate	CE&RoHS					
Lifetime	50,000 hours					
Feature	Uniform light					
Product Size(mm)	89.7*89.7*56	110*110*68	137.5*137.5*82	165*165*91	195*195*107	235*235*127.5
Hole size(mm)	75	90	120	140	170	200
Pcs/Carton (pcs)	48	48	24	18	18	12
Carton Size(mm)	500*480*245	630*580*295	645*350*300	560*550*235	650*635*270	535*510*455
Carton Weight(kg)	19.4	20.86	25.9	33.73	15.31	13.18

88L-DL-103



IP65

Power	10W	15W	20W	25W	30W
Input Voltage	AC100-240V 50/60Hz				
LEDs Brand	EPISTAR				
LEDs Quantity	50	84	120	144	180
Flux	1000 LM	1500 LM	2000 LM	2500 LM	3000 LM
Color temperature	2700K-3200K/Warm White, 4000K-4500K/Neutral White, 6000K-7000K/Cool White				
Color Rendering Index	80				
Driver	CE&RoHS				
Power Factor	>0.9				
Total Harmonic Index	<20%				
Operation Temperature	-30°C ~ 50°C				
IP Rating	IP65				
Beam Angle	120°				
Material	Aluminium				
Certificate	CE&RoHS				
Lifetime	50,000 hours				
Feature	Intergrated body				
Product Size(mm)	95*95*51	115*115*55	155*155*67	195*195*60	235*235*65
Hole size(mm)	85	95	130	170	210
Pcs/Carton (pcs)	45	27	18	12	12
Carton Size(mm)	575*350*360	400*400*405	500*340*405	410*410*400	510*510*400
Carton Weight(kg)	19.4	20.86	25.9	33.73	15.31

88L-DL-104

Power	7W	15W	30W	40W
Input Voltage	AC100-240V 50/60Hz			
LEDs Brand	PHILIPS			
LEDs Quantity	1	1	1	1
Flux	700 LM	1500 LM	3000 LM	4000 LM
Color temperature	2700K-3200K/Warm White, 4000K-4500K/Neutral White, 6000K-7000K/Cool White			
Color Rendering Index	80			
Driver	CE&RoHS			
Power Factor	>0.9			
Total Harmonic Index	<20%			
Operation Temperature	-30°C ~ 50°C			
IP Rating	IP20			
Beam Angle	120°			
Material	Aluminium			
Certificate	CE&RoHS			
Lifetime	50,000 hours			
Feature	Intergrated body			
Product Size(mm)	89*89*95	115*115*140	145*145*160	185*185*205
Hole size(mm)	80	100	130	165
Pcs/Carton (pcs)	50	40	27	18
Carton Size(mm)	580*240*590	620*250*660	470*470*580	650*430*760



88L-DL-105



Power	9W	15W	25W	40W
Input Voltage	AC100-240V 50/60Hz			
LEDs Brand	PHILIPS			
LEDs Quantity	1	1	1	1
Flux	900 LM	1500 LM	2500 LM	4000 LM
Color temperature	2700K-3200K/Warm White, 4000K-4500K/Neutral White, 6000K-7000K/Cool White			
Color Rendering Index	80			
Driver	CE&RoHS			
Power Factor	>0.9			
Total Harmonic Index	<20%			
Operation Temperature	-30°C ~ 50°C			
IP Rating	IP20			
Beam Angle	120°			
Material	Aluminium			
Certificate	CE&RoHS			
Lifetime	50,000 hours			
Feature	Artistic design			
Product Size(mm)	110*110*71	140*140*86	160*160*97	180*180*112
Hole Size(mm)	95*95	115*115	135*135	145*145
Pcs/Carton (pcs)	50	30	20	20
Carton Size(mm)	620*255*455	480*330*530	400*400*450	400*400*650
Carton Weight(kg)	22	26	26	32





LED Strip Lights

Scope of Application

Airport, Bathroom

Bathroom Room, Bedroom, Car Park

Church, Cinema, Gallery, Garage, Hospital

Hotel, Kitchen, Meeting Room, Museum

Office, Restaurant, School

Shopping Mall and other lighting places.

Product Features

- Lightweight and slim, suitable for small spaces.
- Flexible, easy to bend for a variety of shapes
- High quality single color, high brightness, low luminance decay SMD Chip.
- A variety of colors to choose.
- It is trimmable every group LED. Each group that can be cut
- Allow frequent on-off and dim by PWM controller.
- Long lifespan more than 50,000hours.
- No mercury and lead. No UV. No infrared. No radiation. Without causing any flickering, helpful to protect the eyes.
- 3M adhesive backing for easy installation.

88L-LS-5050 CV Strip



5050-60-2meter

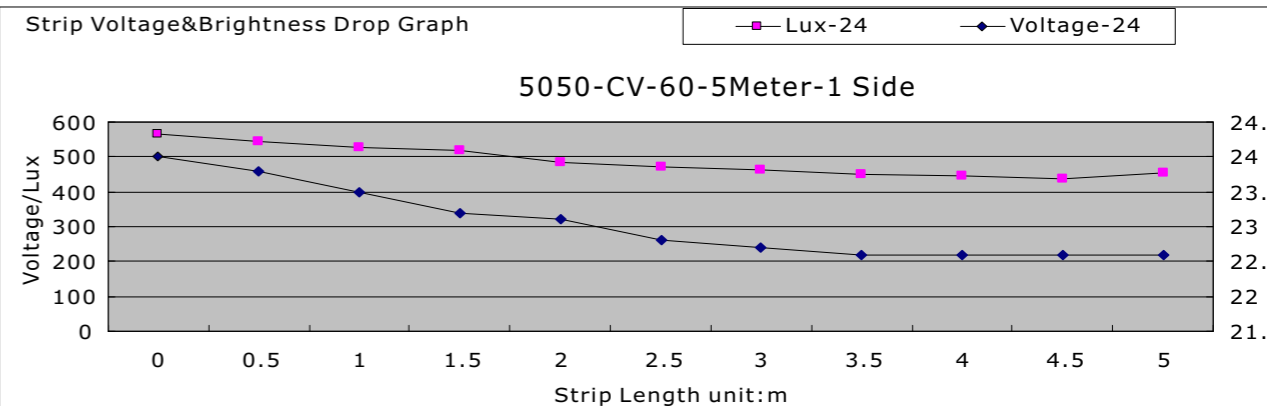
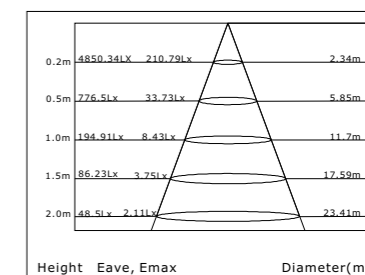
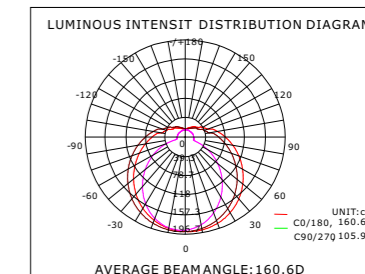

LED Qty(5050)	30	60	72	96	120
Input Voltage	3V/4.5V /5V/ 6V /9V 12V/24V		12V	12V	12V/24V
LEDs Brand	Epistar/Bridgelux				
Normal Color	RGB / R / G /B/ 3000K / 4000K / 6500K(RGBW 60/120LED 12/24V&72LED24V)				
IP Grade	N--IP20/DF&SF--IP64/GF--IP65				
Power/m	7.2W	14.4W	17.28W	23.04W	28W
Special Color	Y / 2200K / 2800K /5000K / CCT				
Special Application	CCT ---30LED/60LED				
Operate Temperature	-20° C~40° C				
Certificate	FCC & CE & RoHS				
Strip Width	IP20 / IP64 DF--10mm & IP64 SF/IP65 GF--12mm				15mm
Package	5m/Roll 1Roll/Bag				
Carton Info	58x38x28cm				
Qty/Carton	IP20 100Bags & IP64 80Bags				50Bags
IP20 Carton Weight	13Kg	13Kg	13Kg	13Kg	12Kg
IP65 Carton Weight	17Kg	18Kg	18Kg	18Kg	19Kg



88L-LS-5050 CC Strip



5050-60-2meter

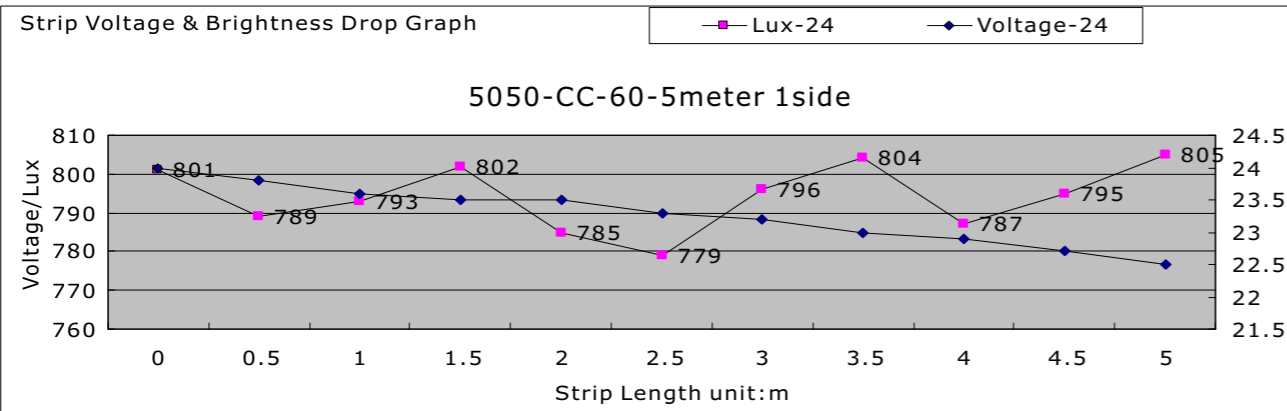
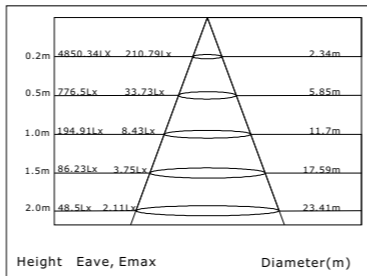
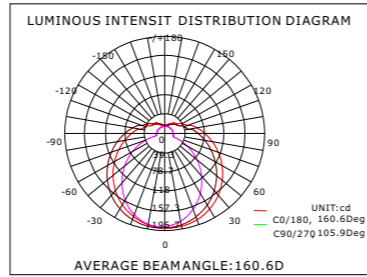

LED Qty(5050)	30	60
Input Voltage	DC24V	
LEDs Brand	Epistar/Bridgelux	
Normal Color	/Blue/Green/3000K/4000K/6500K	
IP Grade	N--IP20/DF--IP64	
Power/m	7.2W	14.4W
Special Color	Orange / 2200K / 2800K / 5000K	
Special Application	Brightness drop less	
Operate Temperature	-20° C~40° C	
Certificate	FCC&CE&RoHS	
Strip Width	10mm	
Package	5m/Roll 1Roll/Bag	
Carton Info	58x38x28cm	
Qty/Carton	100Bags	
IP20 Carton Weight	13Kg	
IP64 Carton Weight	17Kg	

88L-LS-5050 Smart IC Strip



LED Qty(5050)	30	48	60	72	144
Input Voltage	5V / 12V	5V / 12V	5V / 12V	5V	5V
LEDs Brand	Epistar/Bridgelux				
Normal Color	Full Color				
IP Grade	IP20 / IP64				
Power/m	7.2	11.52	14.4	17.28	34.56
Work Style	Digital controller control each dot(group)				
Special Application	Each dot controllable 12V "S" Shape Bendable				
Operate Temperature	-20° C~40° C				
Certificate	FCC & CE & RoHS				
Strip Width	5V10mm/12V12mm	5V12mm/12V10mm	12mm	12mm	
Package	5m/Roll 1Roll/Bag				
Carton Info	58x38x28cm				
Qty/Carton	80 Bags				
IP20 Carton Weight	13Kg				
IP64 Carton Weight	17Kg				

88L-LS-5050 CV Bendable Strip

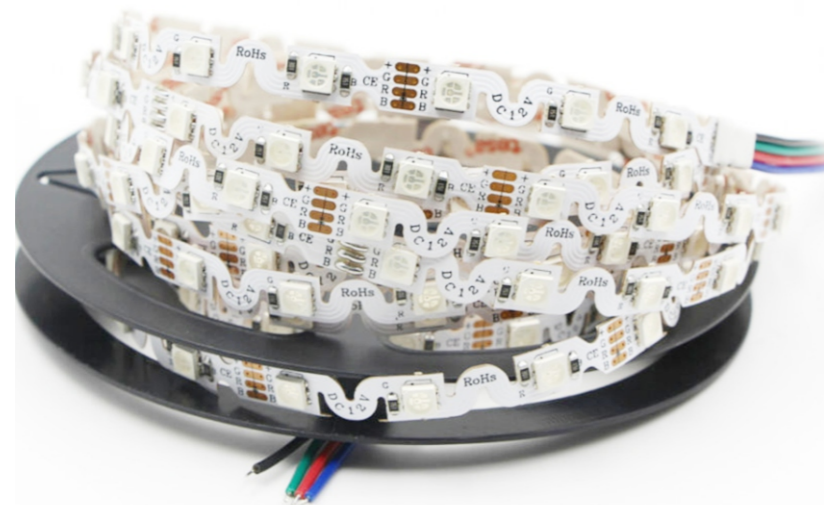

LED Qty(5050)	48	60
Input Voltage	DC12V / DC24V	DC12V
LEDs Brand	Epistar/Bridgelux	
Normal Color	RGB/ Red/Blue/Green/3000K/4000K/6500K	
IP Grade	N--IP20/DF--IP64	
Power/m	11.52W	14.4W
Special Color	Orange / 2200K / 2800K / 5000K	
Special Application	12V Smart 48 LED "S" shape bendable	
Operate Temperature	-20° C~40° C	
Certificate	FCC&CE&RoHS	
Strip Width	8mm	
Package	5m/Roll 1Roll/Bag	
Carton Info	58x38x28cm	
Qty/Carton	100Bags	
IP20 Carton Weight	13Kg	
IP64 Carton Weight	13Kg	

88L-LS-5050 CV MultiColor Strip

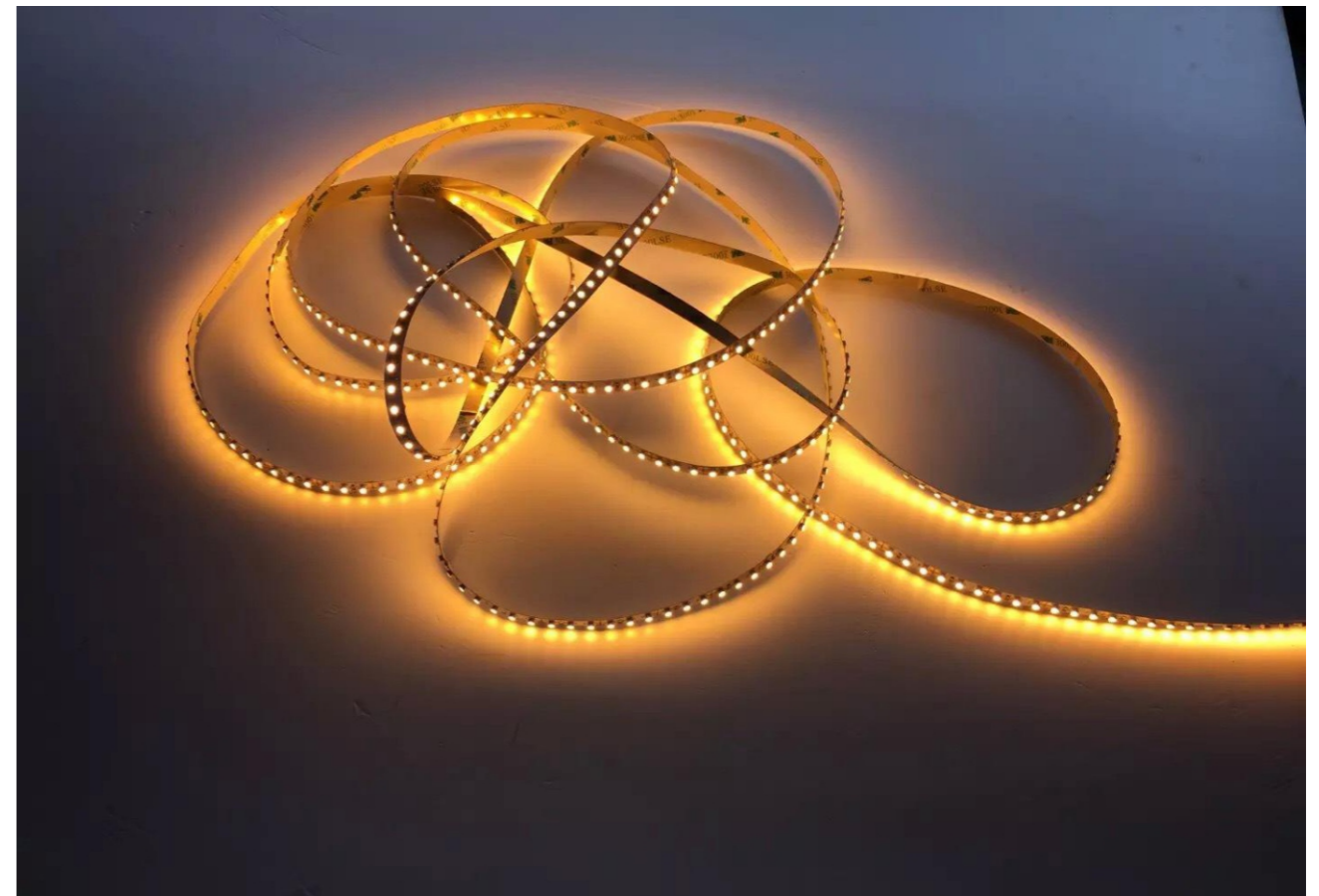

LED Qty(5050)	32	30	60	72	84	96	120	144
Input Voltage	12V	12V	12V/24V	24V	24V	24V	12V/24V	12V
LEDs Brand	Epistar/Bridgelux							
Normal Color	RGBW	RGBW	RGBW	RGBW	RGBW	RGBW	RGBW	RGBW
IP Grade	IP20 / IP64							
Power/m	8W	9.6W	14.4W	17.28W	26.8W	30.6W	19.2W	34.4W
Special Color	RGBCW							
Special Application	RGBW 1 in 1 / RGBW 4 in 1 / RGBCW 5 in 1							
Operate Temperature	-20° C~40° C							
Certificate	FCC & CE & RoHS							
Strip Width	10mm	12mm	10/12mm	12mm	12mm	12mm	15/20mm	20mm
Package	5 meter/ Roll, 1 Roll / Bag							
Carton Info	58x38x28cm							
Qty/Carton	80Bag	60 Bag				50 Bag	50Bags	
IP20 Carton Weight	12Kg							
IP65 Carton Weight	15Kg							

88L-LS-2835 CV Strip

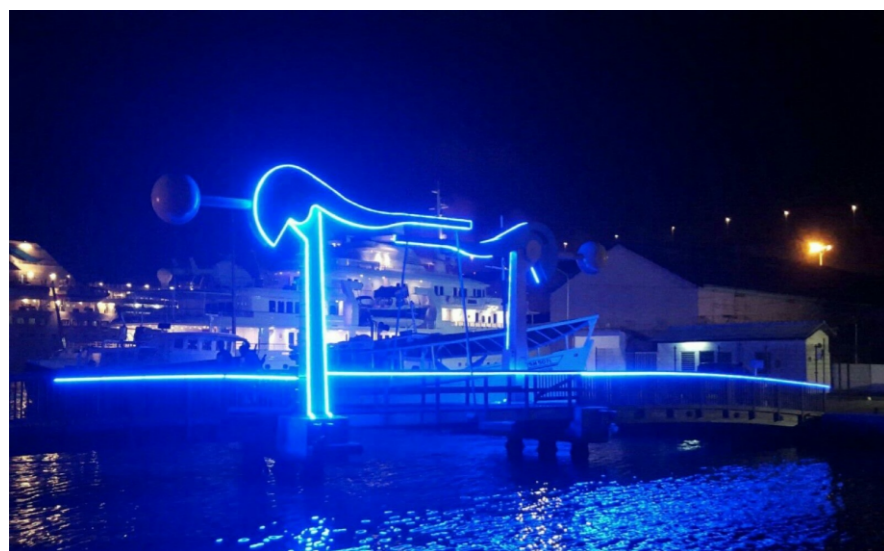

2835-60-2meter

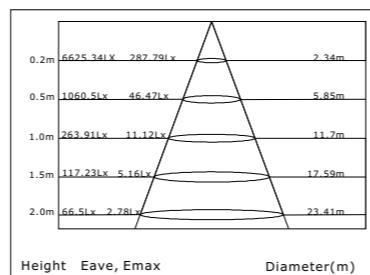
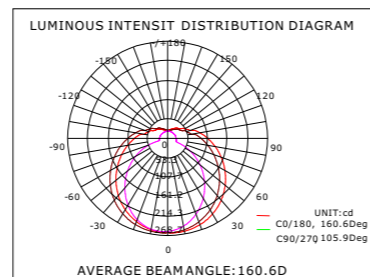

Height Eave, Emax Diameter(m)

Strip Voltage & Brightness Drop Graph

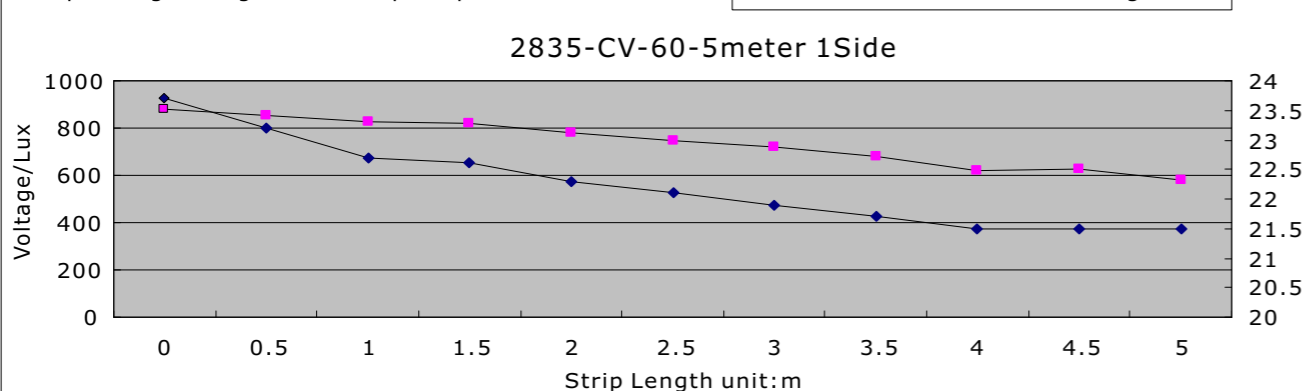

LED Qty(2835)	30	60	72	120	140	240
Input Voltage	12/24V	12/24V	12/24V	12/24V	12/24V	12V
LEDs Brand	Epistar/Bridgelux					
Normal Color	2800K/4000K/5000K/6500K					
IP Grade						
Power/m	6W	12W	12W	24W	24W	48W
Special Color						
Special Application	"S" Shape Bendable					
Operate Temperature	-20° C~40° C					
Certificate	FCC & CE & RoHS					
Strip Width	8mm	8mm	8mm	10mm	10mm	10/15mm
Package	5m/Roll 1Roll/Bag					
Carton Info	58x38x28cm					
Qty/Carton	IP20 100Bags & IP64 80Bags			80/60 Bag		
IP20 Carton Weight	13Kg	13Kg	13Kg	13Kg	12Kg	13Kg
IP65 Carton Weight	17Kg	18Kg	18Kg	18Kg	19Kg	17Kg

88L-LS-2835 CC Strip



2835-60-2meter

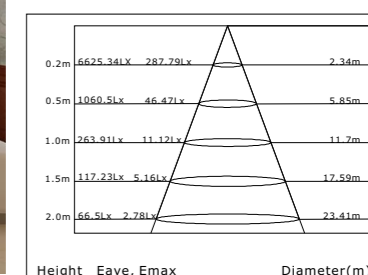
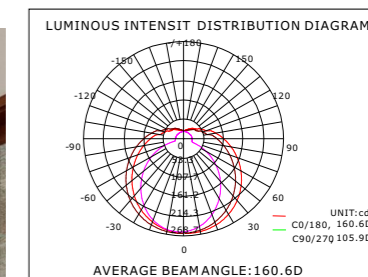

Height Eave, Emax Diameter(m)

Strip Voltage & Brightness Drop Graph

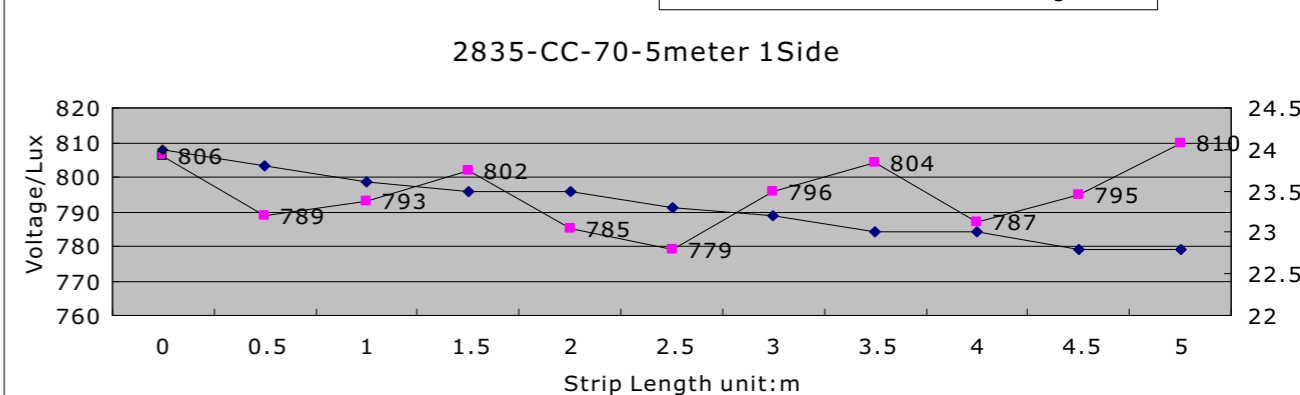

LED Qty(2835)	60	70	112	120	140
Input Voltage	24V				
LEDs Brand	Epistar/Bridgelux				
Normal Color	Blue/Green/2800K/3000K/4000K/6500K				
IP Grade	N--IP20 / IP64 -- Nano				
Power/m	12W	12W	19.2W	19.2W	24W
Special Color	2200K				
Special Application	Brightness drop less				
Operate Temperature	-20° C~40° C				
Certificate	FCC&CE&RoHS				
Strip Width	10mm			15mm	
Package	5m/Roll 1Roll/Bag				
Carton Info	58x38x28cm				
Qty/Carton	80Bags			60 Bag	
IP20 Carton Weight	12Kg			11kg	
IP65 Carton Weight	12Kg			11kg	

88L-LS-3528 CV Strip

3528-120-2meter

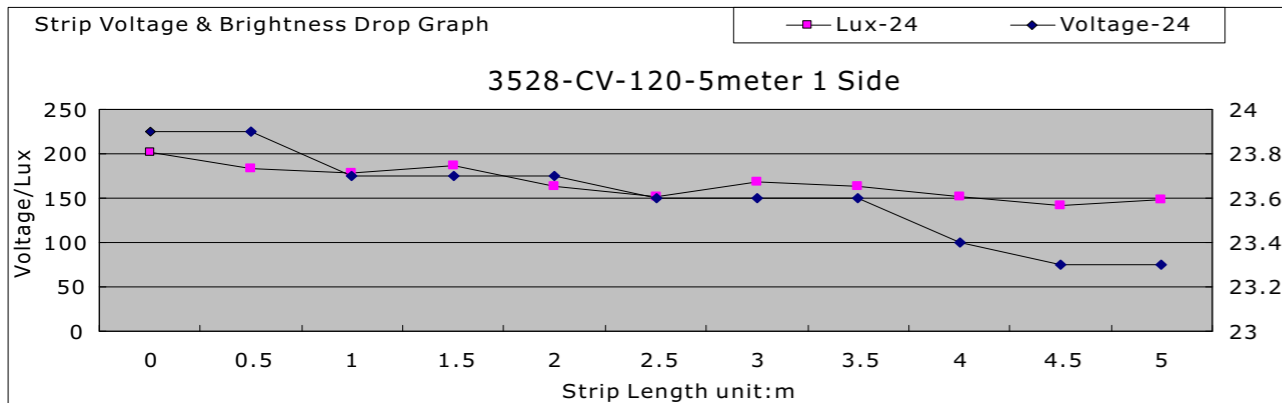
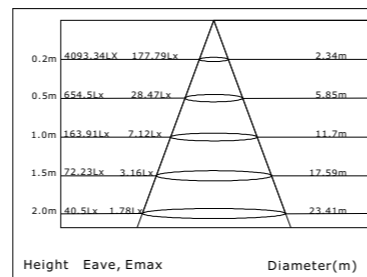
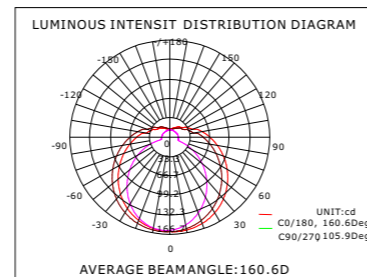

LED Qty(3528)	30	48	60	90	96	108	120	180	240	360	480
Input Voltage	12V	12V/24V	12V	12V/24V			24V	12V			
LEDs Brand	Epistar/Bridgelux										
Normal Color	Red/Green/Blue/2200K/2800K/3000K/4000K/5000K/6500K										
IP Grade	N--IP20/DF&SF--IP64/GF--IP65						N--IP20 / DF--IP64				
Power/m	2.4W	3.84W	4.8W	7.2W	7.68W	8.64W	9.6W	14.4W	19.2W	28.8W	38.4W
Special Color		RGB					CCT		CCT		
Special Application	60LED BD+CCT, 60/80LED 3V-9V, 60LED RGB 3V-9V, 60/120LED 24VCC										
Operate Temperature	-20° C~40° C										
Certificate	FCC&CE&RoHS										
Strip Width	8mm						10mm	10/15mm	20mm	28mm	
Package	5m/Roll 1Roll/Bag										
Carton Info	58x38x28cm										
Qty/Carton	100				70 / 100		60	30			
IP20 Carton Weight	12Kg				12Kg		10kg	9Kg			
IP65 Carton Weight	16Kg				16Kg		16kg	16Kg			

88L-LS-3528 CC Strip

3528-120-2meter

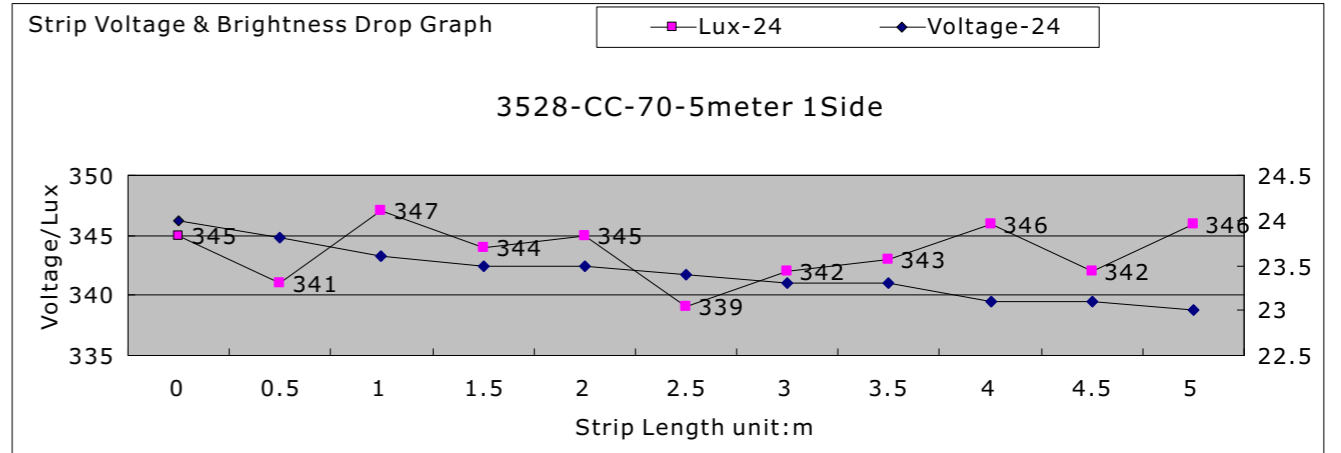
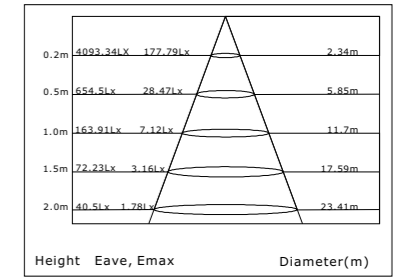
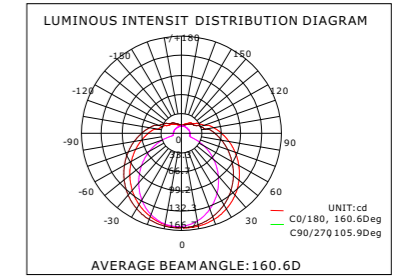

LED Qty(3528)	60	70	112	120	140	228
Input Voltage	24V					
LEDs Brand	Epistar/Bridgelux					
Normal Color	Blue/Green/2800K/3000K/4000K/6500K					
IP Grade	IP20 / IP64--Nano					
Power/m	4.8W	4.8W	7.68W	9.6W	9.6W	18.2W
Special Color	2200K/5000K					
Special Application	Brightness drop less					
Operate Temperature	-20° C~40° C					
Certificate	FCC&CE&RoHS					
Strip Width	10mm	10mm	10mm	10mm	15mm	12mm
Package	5 meter / Roll, 1 Roll/ Bag					
Carton Info	58x38x28cm					
Qty/Carton	80 Bag			50 Bag		60 Bag
IP20 Carton Weight	12Kg					
IP65 Carton Weight	12Kg					

88L-LS-5730 CV Strip



5730-60-2meter

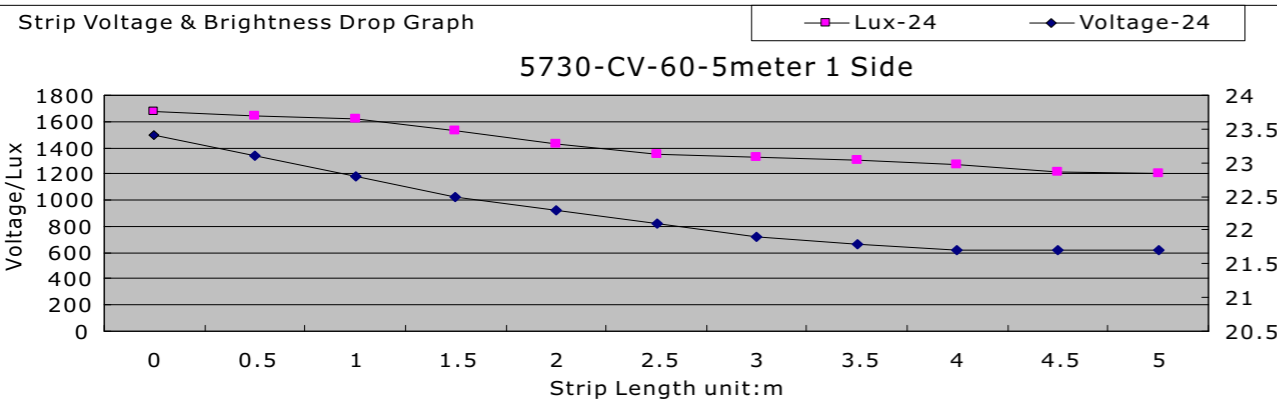
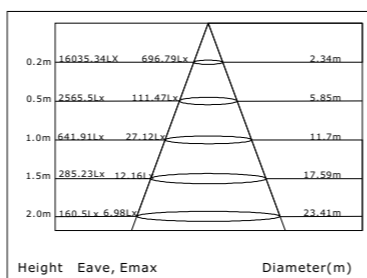
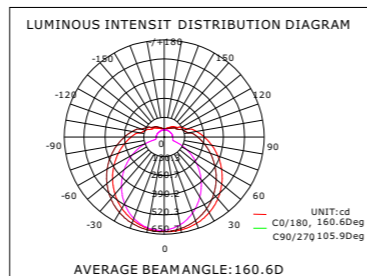

LED Qty(5730)	60	112
Input Voltage	CV 12V/24V	CV 24V
LEDs Brand	Epistar/Bridgelux	
Normal Color	3000K/4000K/6500K	CCT (1--1)
IP Grade	N--IP20/DF&SF--IP64/GF--IP65	
Power/m	30W	56W
Special Color	Orange/Sunset/5000K	
Special Application	Color Temperature Changeable	
Operate Temperature	-20°C~40°C	
Certificate	FCC&CE&RoHS	
Strip Size	5000x10x2mm	5000x10x2mm
Package	5m/Roll 1Roll/Bag	
Carton Info	58x38x28cm	
Qty/Carton	100Bags	100Bags(80Bags IP65)
IP20 Carton Weight	12Kg	12Kg
IP65 Carton Weight	16Kg	16Kg

88L-LS-3014 CV Strip



3014-240-2meter

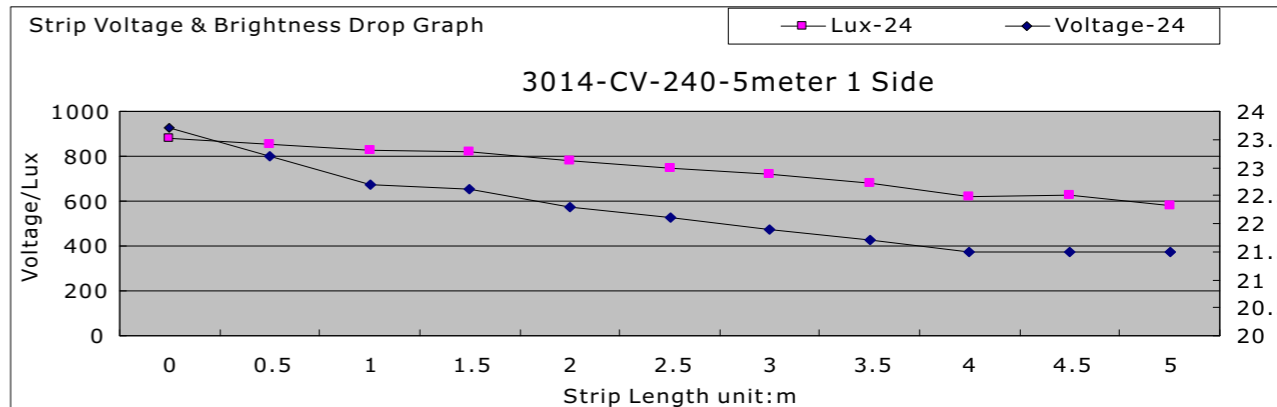
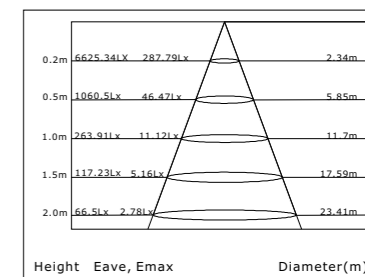
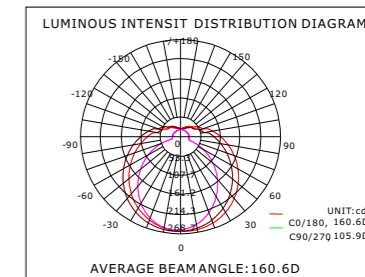

LED Qty(3014)	240
Input Voltage	CV 24V
LEDs Brand	Epistar/Bridgelux
Normal Color	3000K / 4000K / 6500K
IP Grade	N--IP20/GF--IP65
Power/m	24W Max
Feature	Uniform
Special Color	5000K
Operate Temperature	-20°C~40°C
Certificate	FCC&CE&RoHS
Strip Size	5000x10x2mm
Package	5m/Roll 1Roll/Bag
Carton Info	58x38x28cm
Qty/Carton	100Bags (IP65 80 Bags)
IP20 Carton Weight	12Kg
IP65 Carton Weight	16Kg

88L-LS-020 CV Side Strip

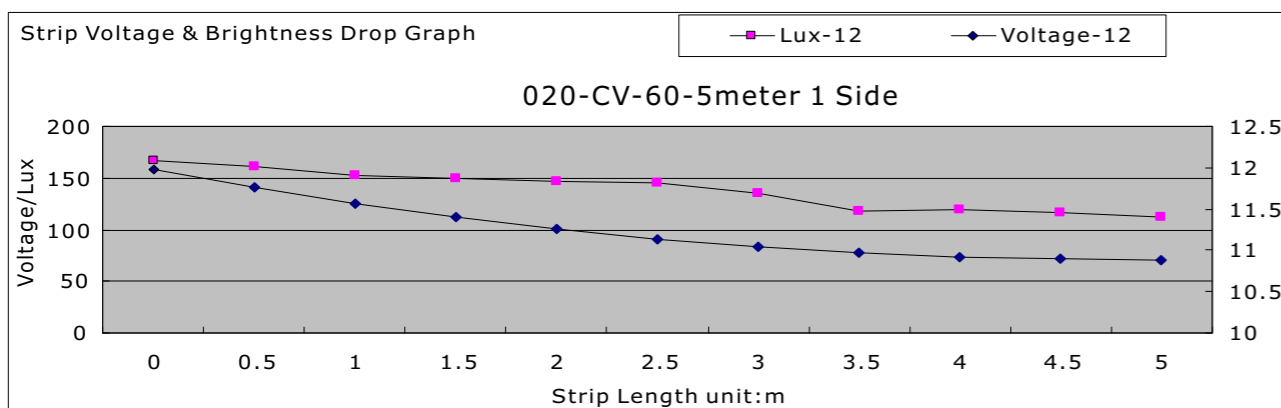

LED Qty	60
Input Voltage	CV 5V/ 12V
LEDs Brand	Epistar/Bridgelux
Normal Color	RGB/ R / B / G / 3000K /4000K /6500K
IP Grade	N--IP20/GF--IP65
Power/m	14.4W Max
Feature	one group one LED
Special Application	Side light 5V for USB
Operate Temperature	-20°C~40°C
Certificate	FCC&CE&RoHS
Strip Size	5000x10x2mm
Package	5m/Roll 1Roll/Bag
Carton Info	58x38x28cm
Qty/Carton	100Bags (IP65 80 Bags)
IP20 Carton Weight	12Kg
IP65 Carton Weight	16Kg

88L-LS-335 CV Side Strip

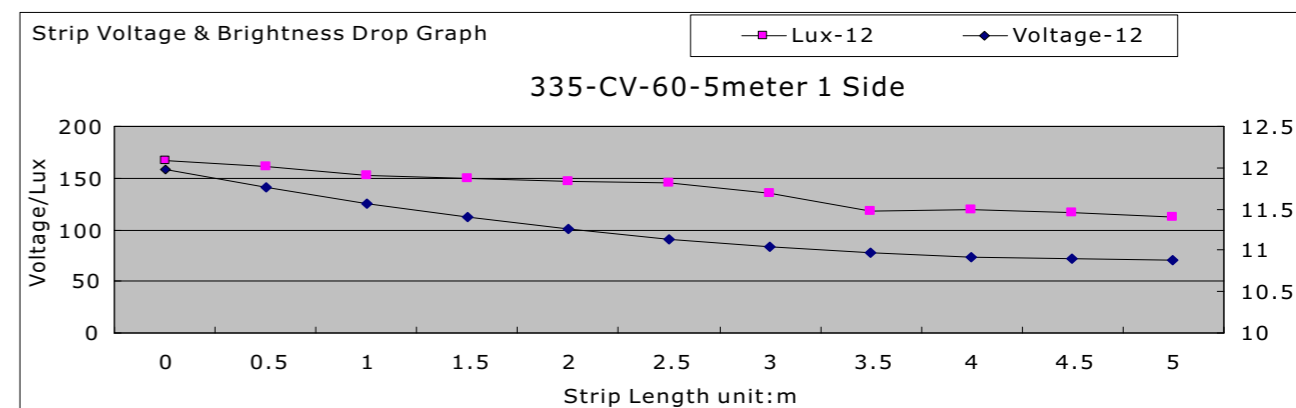

LED Qty	60	96	120
Input Voltage	CV 12V /24V		
LEDs Brand	Epistar/Bridgelux		
Normal Color	RGB/Red/Blue/Green/Yellow/3000K/4000K/6500K		
IP Grade	N--IP20/GF--IP65		
Power/m	4.8W	7.6W	9.6W
Special Color	Orange/Sunset/5000K		
Special Application	Side light		
Operate Temperature	-20°C~40°C		
Certificate	FCC&CE&RoHS		
Strip Size	5000x8x2mm	5000x8x2mm	5000x8x2mm
Package	5m/Roll 1Roll/Bag		
Carton Info	58x38x28cm		
Qty/Carton	100Bags	100Bags	100Bags
IP20 Carton Weight	12Kg	12Kg	12Kg
IP65 Carton Weight	16Kg	16Kg	16Kg



LED Controller

Scope of Application

Airport, Bathroom
 Bathroom Room, Bedroom, Car Park
 Church, Cinema, Gallery, Garage, Hospital
 Hotel, Kitchen, Meeting Room, Museum
 Office, Restaurant, School
 Shopping Mall and other lighting places.

Product Features

- Lightweight and slim, suitable for small spaces.
- Wide range of input voltage from 5V to 24V.
 Keys control, IR remote control, RF remote control options.
- A variety of patterns.
 2.4G, WIFI Remote and Phone Smart Control.
- Allow frequent on-off.
- Long lifespan.
- No mercury and lead. No radiation.
- 3M adhesive /Screws make easy installation.



88L-LSCONT-Mini Series



M11	Single Color Controller	Patterns Qty	5
Input Voltage	CV DC5-24V	Brightness Level	8
Max Current	1x12A=12A	Speed Level	6
Power	12V144W or 24V288W	Input/Output Style	Cable/Connector
Channel Qty	1	Operate Temperature	-30° C~ 60° C
Controller Style	Three Keys	Dimension	46x13x6mm
Feature	Load single color strip 12V144W or 24V288W		



M13	RGB Controller	Patterns Qty	39
Input Voltage	CV DC5-24V	Brightness Level	5
Max Current	3x4A=12A	Speed Level	10
Power	12V144W or 24V288W	Input/Output Style	Cable/Connector
Channel Qty	3	Operate Temperature	-30° C~ 60° C
Controller Style	Three Keys	Dimension	46x13x6mm
Feature	Load RGB color strip 12V144W or 24V288W		



M14	RGBW Controller	Patterns Qty	20
Input Voltage	CV DC7.5-24V	Brightness Level	5
Max Current	4x2A=8A	Speed Level	5
Power	12V96W or 24V192W	Input/Output Style	Cable/Connector
Channel Qty	4	Operate Temperature	-30° C~ 60° C
Controller Style	Three Keys	Dimension	46x13x6mm
Feature	Load RGBW color strip 12V96W or 24V192W		



M21	Single Color Controller	Patterns Qty	8
Input Voltage	CV DC5-24V	Brightness Level	10
Max Current	1x6A=6A	Speed Level	10
Power	12V72W or 24V144W	Input/Output Style	Cable/Connector
Channel Qty	1	Operate Temperature	-30° C~ 60° C
Controller Style	11 Keys RF Remoter	Dimension	46x13x6mm
Feature	Load single color strip 12V72W or 24V144W		



M23	RGB Controller	Patterns Qty	39
Input Voltage	CV DC5-24V	Brightness Level	5
Max Current	3x4A=12A	Speed Level	5
Power	12V144W or 24V288W	Input/Output Style	Cable/Connector
Channel Qty	3	Operate Temperature	-30° C~ 60° C
Controller Style	17 Keys RF Remoter	Dimension	46x13x6mm
Feature	Load RGB color strip 12V144W or 24V288W		

88L-AMPLIFIER



M11	Single Color Amplifier	Power supply	Extra
Input Voltage	CV DC5-24V	Isolated(Yes/No)	No
Max Current	1x12A=12A	Connection Style	Common anode
Power	12V144W or 24V288W	Input/Output Style	Cable/Connector
Channel Qty	1	Operate Temperature	-30° C~ 60° C
Controller Style	Relay the controller	Dimension	42x12x3mm
Feature	Load single color strip 12V72W or 24V144W		



M13	RGB Amplifier	Power supply	Extra
Input Voltage	CV DC5-24V	Isolated(Yes/No)	Yes
Max Current	3x4A=12A	Connection Style	Nop
Power	12V144W or 24V288W	Input/Output Style	Cable/Connector
Channel Qty	3	Operate Temperature	-30° C~ 60° C
Controller Style	Relay the controller	Dimension	42x12x3mm
Feature	Load RGB color strip 12V144W or 24V288W		



M14	RGBW Amplifier	Power supply	Extra
Input Voltage	CV DC5-24V	Isolated(Yes/No)	No
Max Current	4x4A=16A	Connection Style	Nop
Power	12V192W or 24V384W	Input/Output Style	Cable/Connector
Channel Qty	4	Operate Temperature	-30° C~ 60° C
Controller Style	Relay the controller	Dimension	42x14x3mm
Feature	Load RGBW color strip 12V192W or 24V383W		



T85	RGB Amplifier	Power supply	Extra
Input Voltage	CV DC12-24V	Isolated(Yes/No)	Yes
Max Current	3x4A=12A	Connection Style	Nop
Power	12V144W or 24V288W	Input/Output Style	Cable/Connector
Channel Qty	3	Operate Temperature	-30° C~ 60° C
Controller Style	Relay the controller	Dimension	105x65x25mm
Feature	Load RGB color strip 12V144W or 24V288W		



T86	RGBW Amplifier	Power supply	Extra
Input Voltage	CV DC12-24V	Isolated(Yes/No)	Yes
Max Current	4x6A=24A	Connection Style	Nop
Power	12V288W or 24V576W	Input/Output Style	Cable/Connector
Channel Qty	4	Operate Temperature	-30° C~ 60° C
Controller Style	Relay the controller	Dimension	81x64x24mm
Feature	Load RGBW color strip 12V288W or 24V576W		

88L-LSCONT-2.4G Mi Series



T201	Single Color Dimmer	Patterns Qty	1
Input Voltage	CV DC12-24V	Brightness Level	11
Max Current	2x5A=10A	Speed Level	1
Power	12V120W or 24V240W	Input/Output Style	Connector
Channel Qty	2	Operate Temperature	-30° C~ 60° C
Controller Style	2.4G 12Keys Remoter	Dimension	85x45x23mm
Feature	Load strip 12V120W or 24V240W, Group divisible in 30m Range		



T202	CCT Controller	Patterns Qty	12
Input Voltage	CV DC12-24V	Brightness Level	11
Max Current	2x5A=10A	Speed Level	10
Power	12V120W or 24V240W	Input/Output Style	Connector
Channel Qty	2	Operate Temperature	-30° C~ 60° C
Controller Style	2.4G 12Keys Remoter	Dimension	85x45x23mm
Feature	Load strip 12V120W or 24V240W, Group divisible in 30m Range		



T203	RGB Color Controller	Patterns Qty	9
Input Voltage	CV DC12-24V	Brightness Level	11
Max Current	3x3.3A=10A	Speed Level	10
Power	12V120W or 24V240W	Input/Output Style	Connector
Channel Qty	3	Operate Temperature	-30° C~ 60° C
Controller Style	2.4G 16Keys Remoter	Dimension	85x45x23mm
Feature	Load strip 12V120W or 24V240W, Group divisible in 30m Range		



T204	Single Color Dimmer	Patterns Qty	9
Input Voltage	CV DC12-24V	Brightness Level	11
Max Current	4x2.5A=10A	Speed Level	10
Power	12V120W or 24V240W	Input/Output Style	Connector
Channel Qty	4	Operate Temperature	-30° C~ 60° C
Controller Style	2.4G 16Keys Remoter	Dimension	85x45x23mm
Feature	Load strip 12V120W or 24V240W, Group divisible in 30m Range		



T205	Single Color Dimmer	Patterns Qty	9
Input Voltage	CV DC12-24V	Brightness Level	11
Max Current	5x2A=10A	Speed Level	10
Power	12V120W or 24V240W	Input/Output Style	Connector
Channel Qty	5	Operate Temperature	-30° C~ 60° C
Controller Style	2.4G 18Keys Remoter	Dimension	85x45x23mm
Feature	Load strip 12V120W or 24V240W, Group divisible in 30m Range		

88L-LSCONT-2.4G Mi Series



Mi-Ball	Phone Controller	Power supply	Extra USB 5V
Input Voltage	CV DC5V	Communication Mode:	2.4GHz WIFI
Max Current	500mA	Connection Style	Common anode
Power	2W	Match Products	All Mi Series
Channel Qty	1	Operate Temperature	-30° C~ 60° C
Controller Style	Relay control Signal	Dimension	D70xH68mm
Feature	ISO App and ANDROID APP support, Control Mi Controller with Phone		



Mi-Box	Phone Controller	Power supply	Extra USB 5V
Input Voltage	CV DC5V	Communication Mode:	2.4GHz WIFI
Max Current	500mA	Connection Style	Common anode
Power	2W	Match Products	All Mi Series
Channel Qty	1	Operate Temperature	-30° C~ 60° C
Controller Style	Relay control Signal	Dimension	91x66x15mm
Feature	ISO App and ANDROID APP support, Control Mi Controller with Phone		

88L-DIMMER



T53	Single Color Dimmer	Power supply	Extra
Input Voltage	CV DC12-24V	Isolated(Yes/No)	No
Max Current	1x8A=8A	Connection Style	Nop
Power	12V96W or 24V192W	Input/Output Style	Connector
Channel Qty	1	Operate Temperature	-30° C~ 60° C
Controller Style	Dim LED directly	Dimension	110x56x34mm
Feature	Load single color strip 12V96W or 24V192W		



T43	Single Color Dimmer	Power supply	Extra
Input Voltage	CV DC12-24V	Isolated(Yes/No)	No
Max Current	1x8A=8A	Connection Style	Nop
Power	12V96W or 24V192W	Input/Output Style	Connector
Channel Qty	1	Operate Temperature	-30° C~ 60° C
Controller Style	Dim LED directly	Dimension	89x59x35mm
Feature	Load single color strip 12V96W or 24V192W		



T63/64/65	Single Color Dimmer	Power supply	Extra
Input Voltage	DC12-24V&AC110/220V	Isolated(Yes/No)	No
Max Current	DC8A & AC1A.2.5A	Connection Style	Nop
Power	DC96W & AC150W/500W	Input/Output Style	Connector
Channel Qty	1	Operate Temperature	-30° C~ 60° C
Controller Style	Dim LED directly	Dimension	87x87x42mm
Feature	Load strip 12V96W or 24V192W / AC110/220V Lamp 150W/500W		

88L-LSCONT-T Series



T102-RFSIN	Single Color Dimmer	Patterns Qty	1
Input Voltage	CV DC12-24V	Brightness Level	11
Max Current	1x18A=18A	Speed Level	1
Power	12V216W or 24V432W	Input/Output Style	Connector
Channel Qty	1	Operate Temperature	-30° C~ 60° C
Controller Style	2.4G 7Keys Remoter	Dimension	84x79x33mm
Feature	Load strip 12V216W or 24V432W.		



T102-RFCCT	CCT Controller	Patterns Qty	3
Input Voltage	CV DC12-24V	Brightness Level	10
Max Current	2x9A=18A	Speed Level	10
Power	12V216W or 24V432W	Input/Output Style	Connector
Channel Qty	1	Operate Temperature	-30° C~ 60° C
Controller Style	2.4G 7Keys Remoter	Dimension	84x79x33mm
Feature	Load strip 12V216W or 24V432W.		



T102-RFRGB	RGB Controller	Patterns Qty	15
Input Voltage	CV DC5V/12-24V	Brightness Level	10
Max Current	3x6A=18A	Speed Level	10
Power	12V216W or 24V432W	Input/Output Style	Connector
Channel Qty	1	Operate Temperature	-30° C~ 60° C
Controller Style	2.4G 7Keys Remoter	Dimension	84x79x33mm
Feature	Load strip 12V216W or 24V432W.		



T88-IR44	RGB Controller	Patterns Qty	32
Input Voltage	CV DC12-24V	Brightness Level	10
Max Current	3x4A=12A	Speed Level	10
Power	12V144W or 24V288W	Input/Output Style	Connector
Channel Qty	3	Operate Temperature	-30° C~ 60° C
Controller Style	IR 44Keys Remoter	Dimension	126x64x24mm
Feature	Load strip 12V144W or 24V288W		



T88-RF20	RGB Controller	Patterns Qty	14
Input Voltage	CV DC12-24V	Brightness Level	10
Max Current	3x4A=12A	Speed Level	10
Power	12V144W or 24V288W	Input/Output Style	Connector
Channel Qty	3	Operate Temperature	-30° C~ 60° C
Controller Style	RF 20Keys Remoter	Dimension	126x64x24mm
Feature	Load strip 12V144W or 24V288W		

88L-DMX/Digital Series



T1000 S/SRF	DMX RGB Controller	Max dots qty	H1024/L2048
Input Voltage	CV DC5V/7.5-24V	Communication Mode:	Digital Signal
Max Current	500mA	Connection Style	Common Cathode
Power	2W	Match Products	All smart products
Port Qty	1	Operate Temperature	-30° C~ 60° C
Controller Style	4Keys/RF Remoter	Dimension	170x114x42mm
Feature	Programmable in SD card,synchronization, support multi smart IC		



T100K	DMX RGB Controller	Max dots qty	H4096/L8192
Input Voltage	AC220V	Communication Mode:	Digital Signal
Max Current	5mA	Connection Style	Common Cathode
Power	<1W	Match Products	All smart products
Port Qty	8	Operate Temperature	-30° C~ 60° C
Controller Style	SD Card/ Computer	Dimension	200x185x52mm
Feature	Programmable in SD card,synchronization, support multi smart IC		



K1000 C/CRF	DMX RGBW Controller	Max dots qty	H1024/L2048
Input Voltage	CV DC5V-24V	Communication Mode:	Digital Signal
Max Current	500mA	Connection Style	Common Cathode
Power	2W	Match Products	All smart products
Port Qty	1	Operate Temperature	-30° C~ 60° C
Controller Style	4Keys/RF Remoter	Dimension	159x89x24mm
Feature	Programmable in SD card,synchronization, support multi smart IC		



K8000C	DMX RGBW Controller	Max dots qty	H4096/L8192
Input Voltage	DC5V	Communication Mode:	Digital Signal
Max Current	500mA	Connection Style	Common Cathode
Power	<2W	Match Products	All smart products
Port Qty	8	Operate Temperature	-30° C~ 60° C
Controller Style	SD Card/ Computer	Dimension	200x185x52mm
Feature	Programmable in SD card,synchronization, support multi smart IC		



Decoder 3P/4P	DMX Decoder	Address qty	512
Input Voltage	DC12-24V	Communication Mode:	Digital Signal
Max Current	3x10A=30A	Connection Style	Common Cathode
Power	12V360W/ 24V 720W	Match Products	All DMX products
Channel Qty	RGB-3/RGBW-4	Operate Temperature	-30° C~ 60° C
Controller Style	Decoder DMX Signal	Dimension	125x55x45mm
Feature	Match the DMX smart controller to controller CV LED products.		

88L-LSCONT-W Series



B103W	RGB Controller	Patterns Qty	Multi
Input Voltage	CV DC12-24V	Brightness Level	0-100%
Max Current	3x4A=12A	Speed Level	Custom
Power	12V144W or 24V288W	Input/Output Style	Connector
Channel Qty	3	Operate Temperature	-30° C~ 60° C
Controller Style	WIFI	Dimension	58x23x9mm
Feature	Control LED with Phone from WIFI.		



B104 B/W	RGBW Controller	Patterns Qty	Multi
Input Voltage	CV DC12-24V	Brightness Level	0-100%
Max Current	4x3A=12A	Speed Level	Custom
Power	12V144W or 24V288W	Input/Output Style	Connector
Channel Qty	4	Operate Temperature	-30° C~ 60° C
Controller Style	WIFI/Bluetooth	Dimension	58x23x9mm
Feature	Control LED with phone from WIFI or Bluetooth.		



B203W	RGB Controller	Patterns Qty	Multi
Input Voltage	CV DC12-24V	Brightness Level	0-100%
Max Current	3x4A=12A	Speed Level	Custom
Power	12V144W or 24V288W	Input/Output Style	Connector
Channel Qty	3	Operate Temperature	-30° C~ 60° C
Controller Style	WIFI/IR	Dimension	58x23x9mm
Feature	Control LED with Phone from WIFI or IR Remoter.		



B204W	RGBW Controller	Patterns Qty	Multi
Input Voltage	CV DC12-24V	Brightness Level	0-100%
Max Current	4x3A=12A	Speed Level	Custom
Power	12V144W or 24V288W	Input/Output Style	Connector
Channel Qty	4	Operate Temperature	-30° C~ 60° C
Controller Style	WIFI/IR	Dimension	58x23x9mm
Feature	Control LED with Phone from WIFI or IR remoter.		

88L-LSCONT-Timer Controller



TC420	RGBYW Controller	Patterns Qty	Multi
Input Voltage	CV DC12-24V	Brightness Level	0-100%
Max Current	5x4A=20A	Speed Level	Custom
Power	12V240W or 24V480W	Input/Output Style	Connector
Channel Qty	5	Operate Temperature	-30° C~ 60° C
Controller Style	Timer /WiFi /AP	Dimension	120x69x24mm
Feature	Programmable with computer, Multitimer, Dimming level.		

88L-High Power AMP



AMP-HP	Single Color Amplifier	Power supply	Extra
Input Voltage	CV DC5-24V	Isolated(Yes/No)	No
Max Current	1x30A=30A	Connection Style	Common anode
Power	12V360W or 24V720W	Input/Output Style	Connector
Channel Qty	1	Operate Temperature	-30° C~ 60° C
Controller Style	Replay the controller	Dimension	85x66x20mm
Feature	Load single color strip 12V360W or 24V720W in dynamic mode		

88L-High Power Dimmer



DIM-HP-30	Single Color Dimmer	Power supply	Extra
Input Voltage	CV DC5-24V	Pattern Qty	None
Max Current	1x30A=30A	Connection Style	Common anode
Power	12V360W or 24V720W	Input/Output Style	Cable/Connector
Channel Qty	1	Operate Temperature	-30° C~ 60° C
Controller Style	Turn the button	Dimension	85x66x45mm
Feature	Load single color strip 12V180W or 24V360W		



DIM-TD	Single Color Dimmer	Power supply	Extra
Input Voltage	CV DC12-24V	Pattern Qty	No
Max Current	1x8A=8A	Connection Style	Common anode
Power	12V96W or 24V192W	Input/Output Style	Connector
Channel Qty	1	Operate Temperature	-30° C~ 60° C
Controller Style	Touch Dim	Dimension	89x59x35mm
Feature	Load single color strip 12V48W or 24V96W		



DIM-HP-36	Single Color Dimmer	Power supply	Extra
Input Voltage	CV DC12-24V	Pattern Qty	None
Max Current	1x36A=36A	Connection Style	Common anode
Power	12V432W or 24V864W	Input/Output Style	Cable/Connector
Channel Qty	1	Operate Temperature	-30° C~ 60° C
Controller Style	Remote/Button	Dimension	64x52x23mm
Feature	Load single color strip 12V432W or 24V864W in dynamic mode		



DIM-HP-721	Single Color Dimmer	Power supply	Extra
Input Voltage	CV DC12-24V	Pattern Qty	None
Max Current	1x72A=72A	Connection Style	Common anode
Power	12V864W or 24V1728W	Input/Output Style	Cable/Connector
Channel Qty	1	Operate Temperature	-30° C~ 60° C
Controller Style	Remote/Button	Dimension	110x90x42mm
Feature	Load single color strip 12V432W or 24V864W in Static mode		

88L-High Power Dimmer



DIM-HP-722	Single Color Dimmer	Power supply	Extra
Input Voltage	CV DC12-24V	Pattern Qty	None
Max Current	1x72A=72A	Connection Style	Common anode
Power	12V864W or 24V1728W	Input/Output Style	Cable/Connector
Channel Qty	1	Operate Temperature	-30° C~ 60° C
Controller Style	Remote	Dimension	110x90x25mm
Feature	Load single color strip 12V432W or 24V864W in Static mode		

88L-WIFI DMX Controller



DMX-RGBW-X86	Single Color Dimmer	Power supply	Extra
Input Voltage	AC100-240V	Pattern Qty	None
Signal	RF2.4 / DMX512	Connection Style	Common anode
Zoon Qty	4	Input/Output Style	Cable/Connector
Max Distance	30m	Operate Temperature	-20° C~ 60° C
Controller Style	Remote/Button	Dimension	86x86x36mm
Feature	DMX RGBW Controller, 2.4G RF and Cables		



DMX-CONT	DMX Decoder	Power supply	Extra
Input Voltage	CV DC5-24V/CC 12-48V	Pattern Qty	None
Max Current	4x5A/ 4x1A	Connection Style	Common anode
Max Power	CV 20A or CC 46V	Input/Output Style	Cable/Connector
Channel Qty	4	Operate Temperature	-30° C~ 60° C
Controller Style	DMX Decoder	Dimension	175x44x30mm
Feature	Load CV LED lamp or CC LED lamp, Match DMX-RGBW-X86		

88L-Sensor Switch



MS-HV	Sensor Switch	Power supply	Extra
Input Voltage	AC180-240V	Pattern Qty	None
Max Current	1x1A=1A	Connection Style	Common anode
Power	220V 200W	Input/Output Style	Cable/Connector
Channel Qty	1	Operate Temperature	-30° C~ 60° C
Controller Style	Motion Sensor	Dimension	76x39x28mm
Feature	Load single color motion sensor switch 200W		



MS-LV	PIR Sensor Switch	Power supply	Extra
Input Voltage	CV DC5-24V	Isolated(Yes/No)	No
Max Current	1x8A=8A	Connection Style	Common anode
Power	12V96W or 24V192W	Input/Output Style	Connector
Channel Qty	1	Operate Temperature	-30° C~ 60° C
Controller Style	Motion Sensor	Dimension	89x59x35mm
Feature	Load LED Lamp 12V48W or 24V96W		



LED Profile

Scope of Application

Airport, Bathroom
 Bathroom Bedroom, Car Park, Bridge
 Church, Cinema, Gallery, Garage, Hospital
 Hotel, Kitchen, Meeting Room, Museum
 Office, Restaurant, School
 Shopping Mall and other lighting places.

Product Features

- Lightweight and slim, suitable for small spaces.
- Kinds of shape options.
- Suitable for different width of PCB.
- Cut able, length <3000mm(default 2000mm).
- Good heatdipation.
- Long lifespan .
- No mercury and lead.
- 3M adhesive /Screws make easy installation.

88L-Aluminum Profile

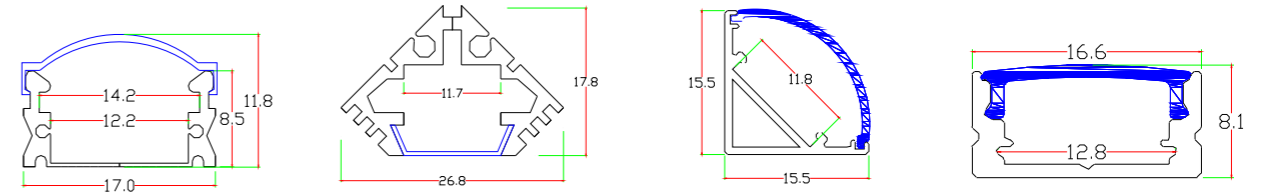

Model	ALP-UB-17	Model	ALP-LA-27	Model	ALP-LA-16	Model	ALP-UD-17S
Dimension	17x9-12	Dimension	27x17-11	Dimension	16x16-12	Dimension	17x8-12
Cover	PC Clear/Milk	Cover	PC Clear/Milk	Cover	PC R/S	Cover	PC/Lens
Plastic Cap	Connector	Plastic Cap	Flat	Plastic Cap	Flat	Plastic Cap	Flat
Aluminum Cap	Flat and L	Aluminum Cap	Nop	Aluminum Cap	Nop	Aluminum Cap	Nop
Clips	Yes	Clips	Yes	Clips	Yes	Clips	Yes
Other	gapless	Other		Other		Other	

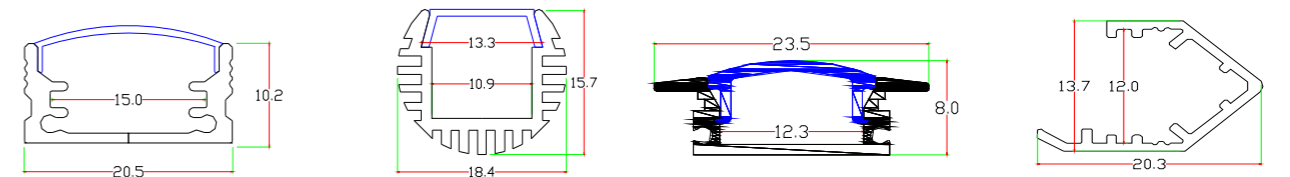

Model	ALP-UA-20	Model	ALP-OA-18	Model	ALP-VA-24	Model	ALP-VC-21
Dimension	20x10-15	Dimension	18x16-11	Dimension	24x8-12	Dimension	21x15-12
Cover	PC Clear/Milk	Cover	PC Clear/Milk	Cover	PC Clear/Milk	Cover	Nop
Plastic Cap	Nop	Plastic Cap	Flat	Plastic Cap	Flat	Plastic Cap	Nop
Aluminum Cap	Flat and L	Aluminum Cap	Nop	Aluminum Cap	Nop	Aluminum Cap	Nop
Clips	Yes	Clips	Yes	Clips	Yes	Clips	Nop
Other		Other		Other		Other	

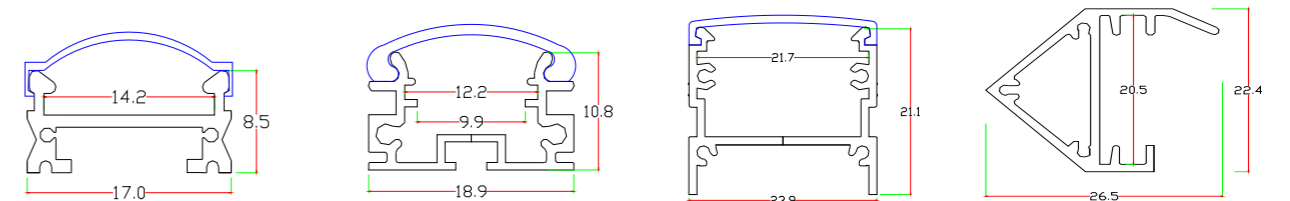

Model	ALP-HA-17	Model	ALP-WA-19	Model	ALP-HB-24	Model	ALP-VC-27
Dimension	17x9-12	Dimension	19x15-15	Dimension	24x23-22	Dimension	26x23-21
Cover	PC Clear/Milk	Cover	PC Clear/Milk	Cover	PC Clear/Milk	Cover	Nop
Plastic Cap	Connector	Plastic Cap	Nop	Plastic Cap	Nop	Plastic Cap	Nop
Aluminum Cap	Flat and L	Aluminum Cap	Flat	Aluminum Cap	Yes	Aluminum Cap	Yes
Clips	Yes	Clips	Yes	Clips	Yes	Clips	Nop
Other	gapless	Other		Other		Other	



88L-Aluminum Profile

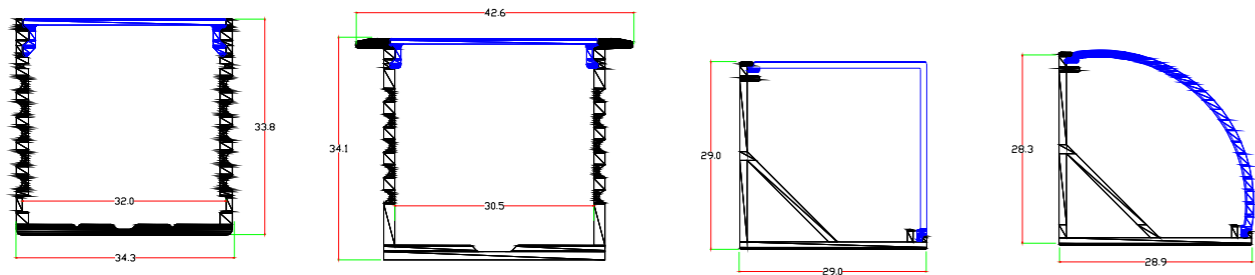

Model	ALP-UA-35	Model	ALP-WA-35	Model	ALP-LA-30S	Model	ALP-LA-30R
Dimension	35x33-35	Dimension	44x35-35	Dimension	30x30-20	Dimension	30x30-20
Cover	PC Clear/Milk	Cover	PC Clear/Milk	Cover	PC Clear/Milk	Cover	PC Clear/Milk
Plastic Cap	Flat	Plastic Cap	Flat	Plastic Cap	Flat	Plastic Cap	Flat
Aluminum Cap	Nop	Aluminum Cap	Nop	Aluminum Cap	Nop	Aluminum Cap	Nop
Clips	Yes	Clips	Yes	Clips	Yes	Clips	Yes
Other		Other		Other		Other	

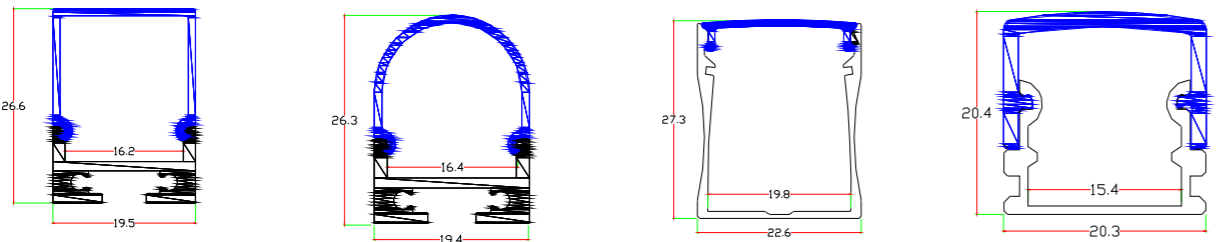

Model	ALP-HA-21S	Model	ALP-HA-21R	Model	ALP-UB-20	Model	ALP-UB-21
Dimension	20x11-16	Dimension	20x11-16	Dimension	20x28-20	Dimension	21x14-15.5
Cover	PC Clear/Milk	Cover	PC Clear/Milk	Cover	PC Milk	Cover	PC Milk
Plastic Cap	Flat/Connect	Plastic Cap	Flat/Connect	Plastic Cap	Nop	Plastic Cap	Flat
Aluminum Cap	Nop	Aluminum Cap	Nop	Aluminum Cap	Flat	Aluminum Cap	Nop
Clips	Yes	Clips	Yes	Clips	Yes	Clips	Yes
Other	Hang Rope	Other	Hang Rope	Other		Other	

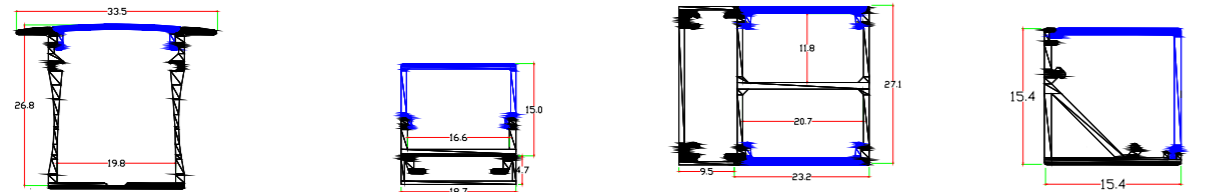

Model	ALP-WA-24	Model	ALP-HA-19	Model	ALP-HA-26	Model	ALP-LA-16S
Dimension	34x28-20	Dimension	20x11-17	Dimension	36x28-19	Dimension	16x16-12
Cover	PC Milk	Cover	PC Milk	Cover	PC Milk	Cover	PC Clear/Milk
Plastic Cap	Nop	Plastic Cap	Nop	Plastic Cap	Nop	Plastic Cap	Flat
Aluminum Cap	Flat	Aluminum Cap	Flat	Aluminum Cap	Flat	Aluminum Cap	Nop
Clips	Yes	Clips	Yes	Clips	Yes	Clips	Yes
Other		Other		Other		Other	

88L-Aluminum Profile

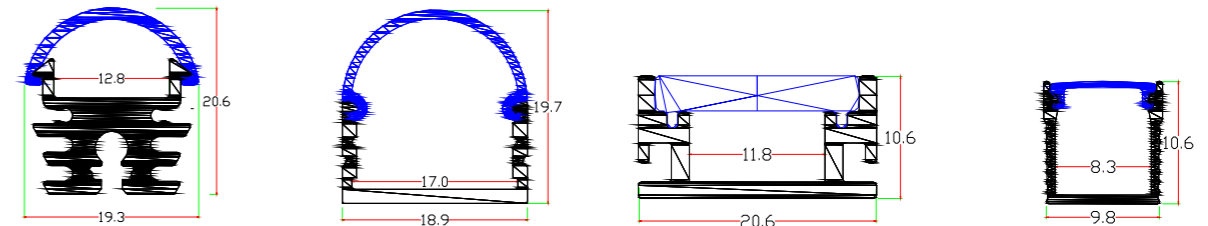

Model	ALP-RA-18	Model	ALP-UC-20	Model	ALP-WA-20	Model	ALP-UD-20
Dimension	18x16-13	Dimension	20x11-17	Dimension	21x11-12	Dimension	11x11-8
Cover	PC Milk	Cover	PC Clear/Milk	Cover	PC Milk	Cover	PC Milk
Plastic Cap	Nop	Plastic Cap	Flat	Plastic Cap	Flat	Plastic Cap	Flat
Aluminum Cap	Flat	Aluminum Cap	Flat	Aluminum Cap	Nop	Aluminum Cap	Nop
Clips	Yes	Clips	Yes	Clips	Nop	Clips	Yes
Other		Other		Other		Other	

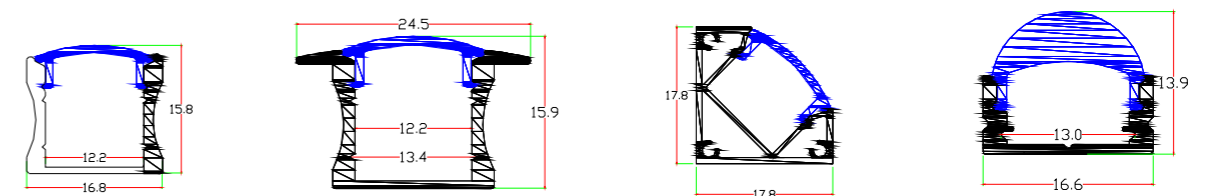

Model	ALP-UA-18	Model	ALP-WA-17	Model	ALP-LB-27	Model	ALP-UE-18
Dimension	18x15-12	Dimension	25x15-12	Dimension	26x18-12	Dimension	18x7-12
Cover	PC Clear/Milk	Cover	PC Clear/Milk	Cover	PC Clear/Milk	Cover	PC Clear/Milk
Plastic Cap	Flat	Plastic Cap	Flat	Plastic Cap	Flat	Plastic Cap	Flat
Aluminum Cap	Nop	Aluminum Cap	Nop	Aluminum Cap	Nop	Aluminum Cap	Nop
Clips	Yes	Clips	Yes	Clips	Yes	Clips	Yes
Other		Other		Other		Other	

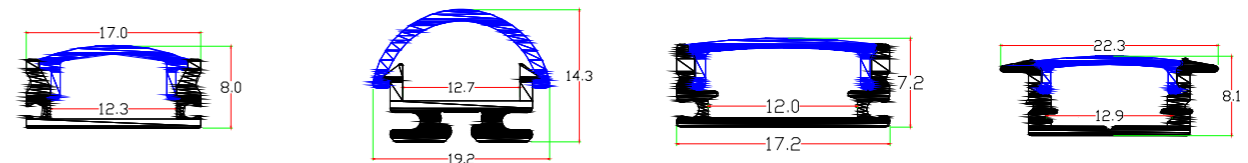

Model	ALP-VA-18	Model	ALP-RA-16	Model	ALP-UE-18	Model	ALP-UF-18
Dimension	18x7-12	Dimension	16x9-13	Dimension	18x7-12	Dimension	17x8-11
Cover	PC Clear/Milk	Cover	PC Clear	Cover	PC Clear/Milk	Cover	PC Clear/Milk
Plastic Cap	Flat	Plastic Cap	Flat	Plastic Cap	Nop	Plastic Cap	Flat
Aluminum Cap	Flat	Aluminum Cap	Flat	Aluminum Cap	Flat	Aluminum Cap	Nop
Clips	Yes	Clips	Yes	Clips	Yes	Clips	Nop
Other		Other		Other		Other	

88L-Aluminum Profile

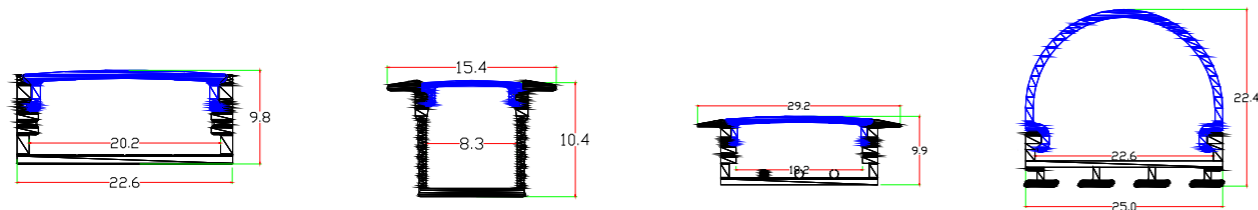

Model	ALP-UA-23	Model	ALP-UA-14	Model	ALP-VA-23	Model	ALP-MA-26R
Dimension	24x10-20	Dimension	14x11-8	Dimension	30x10-20	Dimension	26x7-23
Cover	PC Milk	Cover	PC Milk	Cover	PC Milk	Cover	PC Milk
Plastic Cap	Flat	Plastic Cap	Flat	Plastic Cap	Flat	Plastic Cap	Flat
Aluminum Cap	Nop	Aluminum Cap	Nop	Aluminum Cap	Nop	Aluminum Cap	Nop
Clips	Yes	Clips	Yes	Clips	Yes	Clips	Yes
Other		Other		Other		Other	



Model	ALP-MA-26S	Model	ALP-HA-08	Model	ALP-HA-11	Model	ALP-LS-014
Dimension	26x7-23	Dimension	8x11-5	Dimension	11x13-5	Dimension	17x8-12
Cover	PC Milk	Cover	PC Milk	Cover	PC Milk	Cover	PC Clear/Milk
Plastic Cap	Flat	Plastic Cap	Flat	Plastic Cap	Flat	Plastic Cap	Flat
Aluminum Cap	Nop	Aluminum Cap	Nop	Aluminum Cap	Nop	Aluminum Cap	Nop
Clips	Yes	Clips	Nop	Clips	Nop	Clips	Yes
Other		Other		Other		Other	

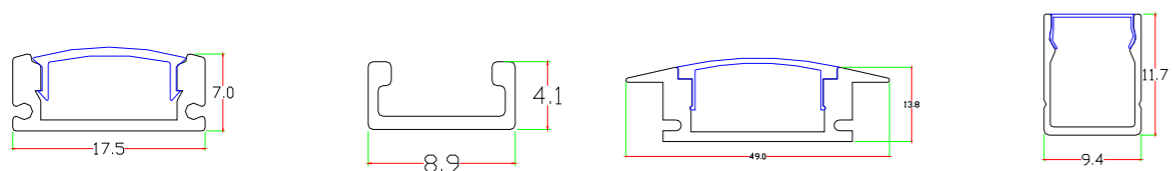

Model	ALP-LS-007	Model	ALP-LS-016	Model	ALP-LS-019	Model	ALP-LS-020
Dimension	17x8-12	Dimension	9x4-6	Dimension	25x7-12	Dimension	10x12-8
Cover	PC Milk	Cover	Nop	Cover	PC Milk	Cover	PC Milk
Plastic Cap	Flat	Plastic Cap	Nop	Plastic Cap	Flat	Plastic Cap	Flat
Aluminum Cap	Flat	Aluminum Cap	Nop	Aluminum Cap	Nop	Aluminum Cap	Nop
Clips	Yes	Clips	Nop	Clips	Yes	Clips	Yes
Other		Other		Other		Other	

88L-Aluminum Profile

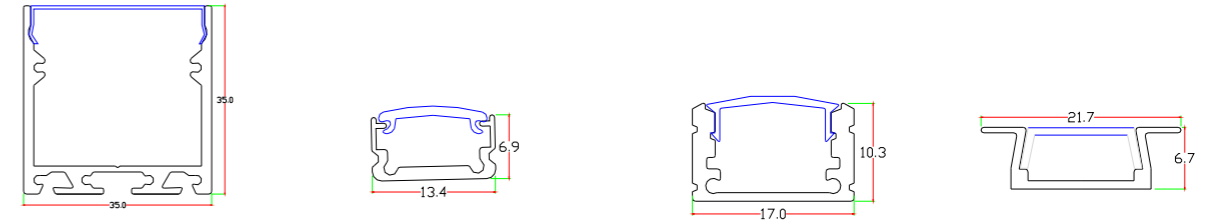

Model	ALP-LS-028	Model	ALP-LS-037	Model	ALP-LS-039	Model	ALP-LS-047
Dimension	35x35-31	Dimension	13x7-12	Dimension	17x10-13	Dimension	22x7-11
Cover	PC Milk	Cover	PC Milk	Cover	PC Milk	Cover	PC Milk
Plastic Cap	Nop	Plastic Cap	Flat	Plastic Cap	Nop	Plastic Cap	ABS L
Aluminum Cap	Flat	Aluminum Cap	Flat	Aluminum Cap	Flat	Aluminum Cap	Nop
Clips	Yes	Clips	Yes	Clips	Yes	Clips	Yes
Other		Other		Other		Other	

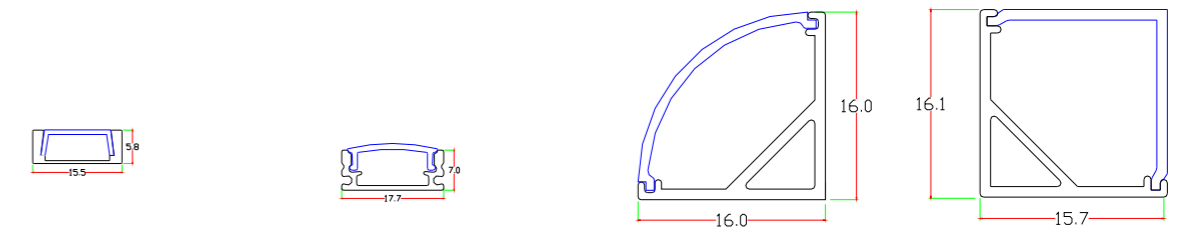

Model	ALP-LS-048	Model	ALP-LS-052	Model	ALP-LS-053	Model	ALP-LS-053A
Dimension	15x6-11	Dimension	18x7-12	Dimension	16x16-10	Dimension	16x16-10
Cover	PC Milk	Cover	PC Milk	Cover	PC Milk	Cover	PC Milk
Plastic Cap	ABS Flat	Plastic Cap	Flat	Plastic Cap	Flat	Plastic Cap	ABS Flat
Aluminum Cap	Nop	Aluminum Cap	L and Flat	Aluminum Cap	Nop	Aluminum Cap	Nop
Clips	Yes	Clips	Yes	Clips	Yes	Clips	Yes
Other		Other		Other		Other	

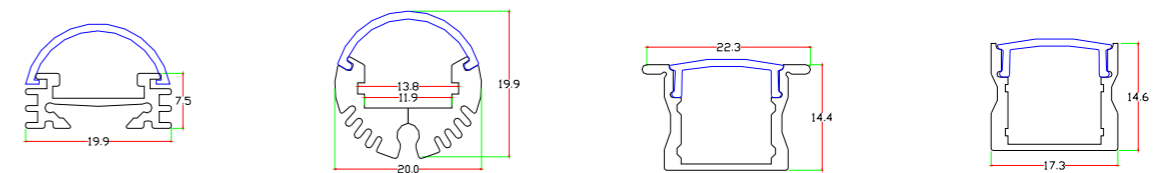

Model	ALP-LS-061	Model	ALP-LS-025	Model	ALP-LS-054	Model	ALP-LS-055
Dimension	20x7-12	Dimension	20x20-12/14	Dimension	24x15-12	Dimension	17x15-12
Cover	PC Milk	Cover	Milk/Clear	Cover	PC Milk	Cover	PC Milk
Plastic Cap	Frosted Flat	Plastic Cap	Flat	Plastic Cap	ABS Flat	Plastic Cap	Flat
Aluminum Cap	Nop	Aluminum Cap	Nop	Aluminum Cap	Nop	Aluminum Cap	Nop
Clips	Yes	Clips	Yes	Clips	Yes	Clips	Yes
Other		Other	Rope	Other		Other	

88L-Aluminum Profile

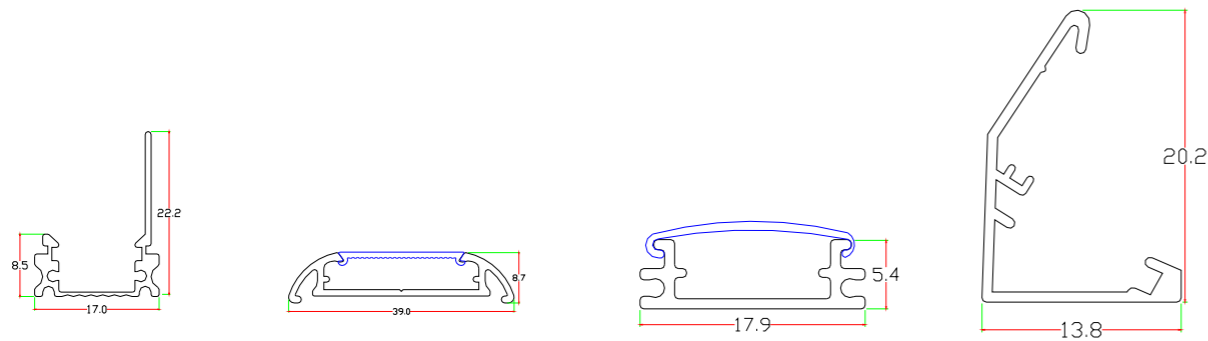

Model	ALP-LS-056	Model	ALP-LS-046	Model	ALP-LS-051	Model	ALP-LS-033
Dimension	17x23-12	Dimension	39x9-26	Dimension	18x6-12	Dimension	20x12-12
Cover	Nop	Cover	PC Milk	Cover	PC Milk	Cover	Reflector
Plastic Cap	Nop	Plastic Cap	Flat	Plastic Cap	Nop	Plastic Cap	Connector
Aluminum Cap	Flat and L	Aluminum Cap	Nop	Aluminum Cap	L	Aluminum Cap	Nop
Clips	Yes	Clips	Yes	Clips	Yes	Clips	Nop
Other	Adjust	Other		Other		Other	Corners

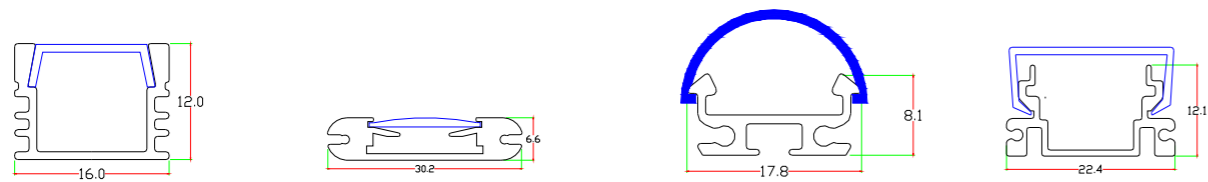

Model	ALP-LS-049	Model	ALP-LS-034	Model	ALP-LS-035	Model	ALP-LS-068
Dimension	16x12-11	Dimension	30x7-18	Dimension	18x9-13.8	Dimension	23x14-12
Cover	PC Milk	Cover	PC Milk	Cover	PC Milk	Cover	PC Clear
Plastic Cap	ABS Flat	Plastic Cap	Flat	Plastic Cap	Nop	Plastic Cap	Nop
Aluminum Cap	Nop	Aluminum Cap	Nop	Aluminum Cap	Flat	Aluminum Cap	Flat
Clips	Yes	Clips	Yes	Clips	Yes	Clips	Yes
Other		Other		Other		Other	

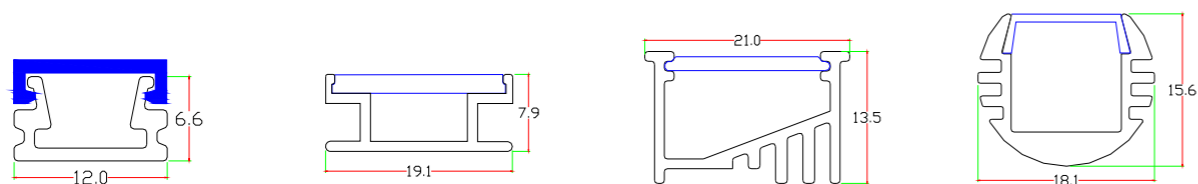

Model	ALP-LS-021	Model	ALP-LS-075	Model	ALP-LS-040	Model	ALP-LS-043
Dimension	12x7-8	Dimension	19x8-10	Dimension	21x13.5-13	Dimension	22x12-11
Cover	PC Milk	Cover	PC Milk	Cover	PC Milk	Cover	PC Milk
Plastic Cap	Flat	Plastic Cap	Flat	Plastic Cap	Flat	Plastic Cap	ABS L
Aluminum Cap	Nop	Aluminum Cap	Nop	Aluminum Cap	Nop	Aluminum Cap	Nop
Clips	Yes	Clips	Nop	Clips	Yes	Clips	Yes
Other		Other		Other		Other	

88L-Aluminum Profile

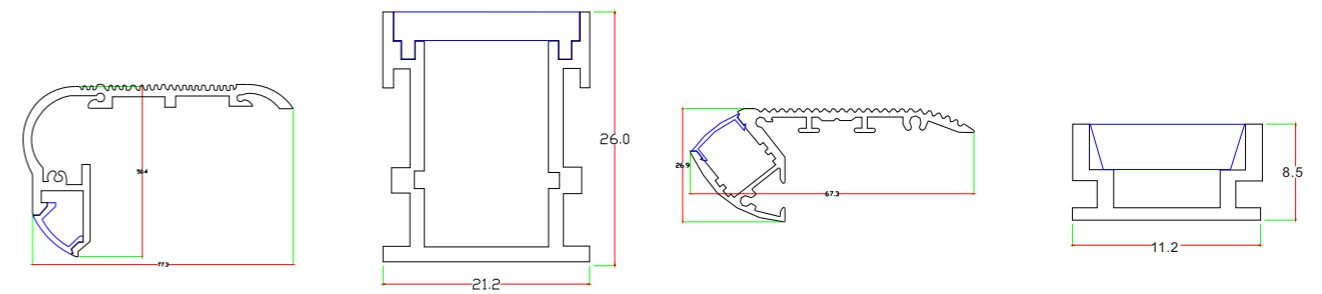

Model	ALP-KC-086	Model	ALP-LS-0101	Model	ALP-LS-0103	Model	ALP-QS-1908
Dimension	80x50-12	Dimension	21x26-12/13	Dimension	66x27-10	Dimension	19x8.5-11
Cover	PC Milk	Cover	PC Milk	Cover	PC Milk	Cover	PC Milk
Plastic Cap	Flat	Plastic Cap	ABS Flat	Plastic Cap	Flat	Plastic Cap	Flat
Aluminum Cap	Nop	Aluminum Cap	Nop	Aluminum Cap	Nop	Aluminum Cap	Nop
Clips	Nop	Clips	Nop	Clips	Nop	Clips	Yes
Other	Fit Step	Other	Fit Ground	Other	Fit Step	Other	Fit Ground

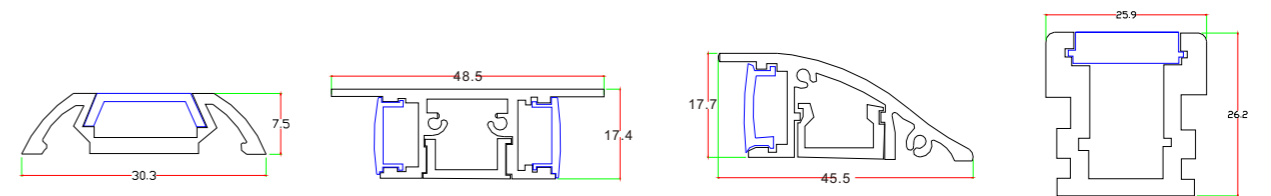

Model	ALP-QS-3006	Model	ALP-QS-1848	Model	ALP-QS-1844	Model	ALP-QS-2626
Dimension	30x7-13	Dimension	48.5x18-12	Dimension	45x18-13	Dimension	26x26-12
Cover	PC Milk	Cover	PC Milkx2	Cover	PC Milk	Cover	PC Milk
Plastic Cap	Flat	Plastic Cap	Flat	Plastic Cap	Nop	Plastic Cap	Flat
Aluminum Cap	Nop	Aluminum Cap	Nop	Aluminum Cap	Nop	Aluminum Cap	Nop
Clips	Yes	Clips	Nop	Clips	Nop	Clips	Nop
Other	Fit Wall	Other	Fit Wall	Other	Fit Wall	Other	Fit Ground

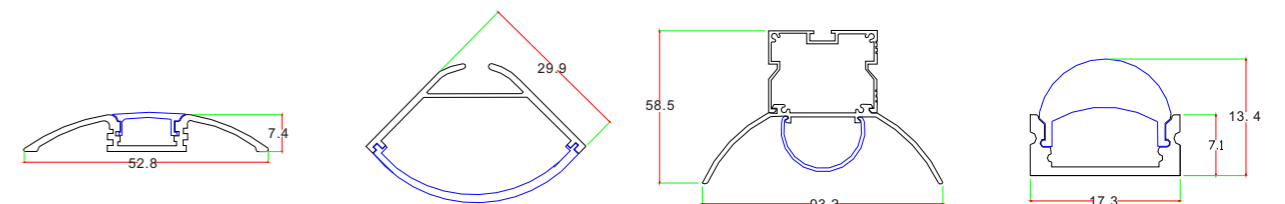

Model	ALP-QS-5208	Model	ALP-QS-3030E	Model	ALP-YD-9358	Model	ALP-YD-1302
Dimension	52x7.4-12	Dimension	30x30-20	Dimension	93x58-25	Dimension	17.3x13.4-12
Cover	PC Milk	Cover	PC Milk	Cover	PC Milk	Cover	PMMA Lens
Plastic Cap	Flat	Plastic Cap	Flat	Plastic Cap	Nop	Plastic Cap	Flat
Aluminum Cap	Nop	Aluminum Cap	Nop	Aluminum Cap	Flat	Aluminum Cap	Nop
Clips	Yes	Clips	Plastic	Clips	Yes	Clips	Yes
Other	Fit Wall	Other		Other		Other	



LED Cornlight

Scope of Application

- Warehouse, Parking lots.
- Railwaystation, Motorway, Rural street.
- Bank, Hospital
- Hotel, Exhibition hall, Residence
- Office, Restaurant, School
- Shopping Mall and other lighting places.

Product Features

- Energy saving long service life.
- Large cooling surface and low heat ensure long lifespan.
- Kinds of color options.
- Internal driver, large range of input voltage from AC85-265V.
- Instant start, no flickering, no humming.
- Easy to install and operate, different bases available.
- No mercury and lead, green and eco-friendly.
- 360 degree lighting, high CRI, no UV, no IR and soft light, safe to eyes.

88L-Cornlight IP40

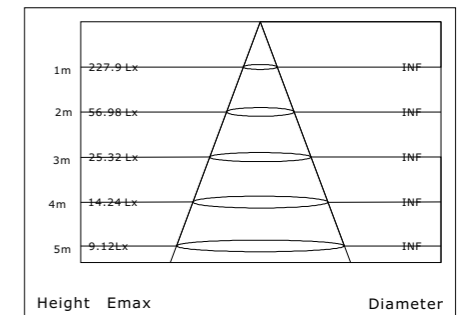
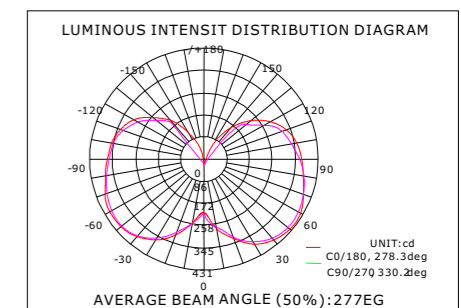

Power Consumption	15W	22W	33W	45W	67W	88W	110W
LED Qty	108	108	225	280	400	560	728
Lumens(Lm)	1725	2310	3400	4700	7000	9200	11500
Input Voltage	AC85-265V						
PF	0.95						
LEDs Brand	Epistar (SMD 2835)						
Normal Color	3000K /4000K /6000K						
CRI	>80						
IP Grade	IP40						
Dimension(mm)	73x160	73x155	90x210	90x230	90x275	112x255	112x265
Base	E27/B22		E27/E40/B22			E40	
Beam angle	360 Degree						
Operate Temperature	-25° C~40° C						
Certificate	CE & RoHS						
Box Size(cm)	21x10x10		25x12x12	29x12x12	31x12x12	33x12x12	34x12x12
Box Weight	0.34	0.34	0.41	0.41	0.65	0.8	0.85
Carton Dimension(cm)	54x42x27		54x42x28	54x28x33	51x38x33	51x38x35	51x38x37
Qty/Carton	12						
Carton Weight(kg)	4.8	4.8	5.7	6.5	8.8	11	12



88L-Cornlight IP64

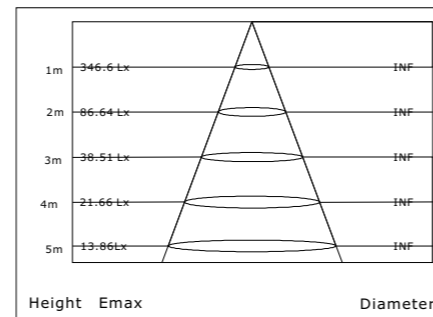
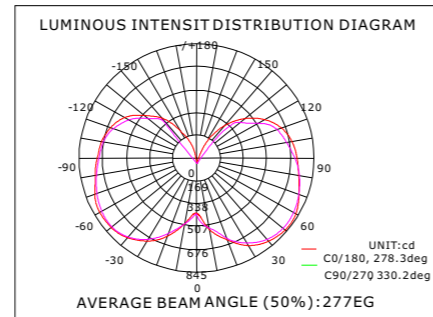

88 Watts Cornlight Diagram

Power Consumption	33W	45W	67W	88W	110W
LED Qty	228	288	416	560	728
Lumens(Lm)	3400	4700	7000	9200	11500
Input Voltage	AC85-265V				
PF	0.95				
LEDs Brand	Epistar (SMD 2835)				
Normal Color	3000K / 4000K / 6000K				
CRI	>80				
IP Grade	IP64				
dimension(mm)	93x225	93x255	93x305	125x270	125x290
Base	E27/E40/B22			E40	
Beam angle	360 Degree				
Operate Temperature	-25° C~40° C				
Certificate	CE & RoHS				
Box size(cm)	25x12x12	29x12x12	31x12x12	33x12x12	34x12x12
Box Weight	0.41	0.41	0.65	0.8	0.85
Carton dimension(cm)	54x42x28	54x28x33	51x38x33	51x38x35	51x38x37
Qty/Carton	12				
Carton Weight(kg)	5.7	6.5	8.8	11	12

88L-Cornlight PLT IP64

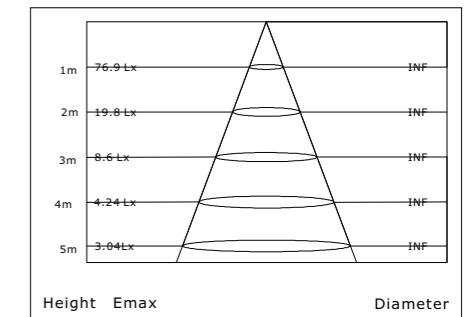
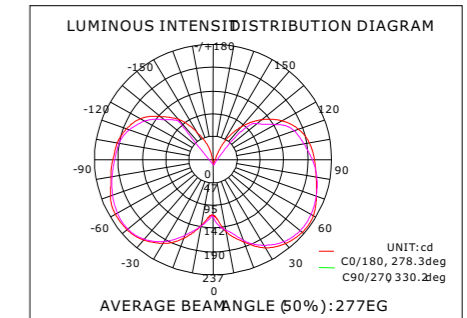

22 Watts Cornlight Diagram

Power Consumption	7W	9W	12W	15W	22W
LED Qty	64	84	98	120	140
Lumens(Lm)	760	980	1300	1650	2180
Input Voltage	AC85-265V				
PF	0.95				
LEDs Brand	Epistar (SMD 2835)				
Normal Color	3000K / 4000K / 6000K				
CRI	>80				
IP Grade	IP64				
dimension(mm)	45x123	45x138	45x158	55x155	55x175
Base	G24 / GX24 / E27 / B22				
Beam angle	360 Degree				
Operate Temperature	-25° C~40° C				
Certificate	CE & RoHS				
Box size(cm)	21x10x10				
Box Weight	0.31	0.32	0.34	0.34	0.36
Carton dimension(cm)	54x42x27				
Qty/Carton	24				
Carton Weight(kg)	4.8				



LED Modules

Scope of Application

- Warehouse, Parking lots.
- Backlighting, Advertising.
- Bank, Hospital
- Hotel, Exhibition hall, Residence
- Office, Restaurant, School
- Shopping Mall and other lighting places.

Product Features

- Energy saving long service life.
- Small, flexible, cuttable .
- Kinds of color options.
- DC12/24V constant voltage input.
- Instant start, no flickering, no humming.
- Easy to install and operate, different bases available.
- No mercury and lead, green and eco-friendly.
- High CRI, no UV, no IR and soft light, safe to eyes.
- Dimmable .

88L-5050 Modules

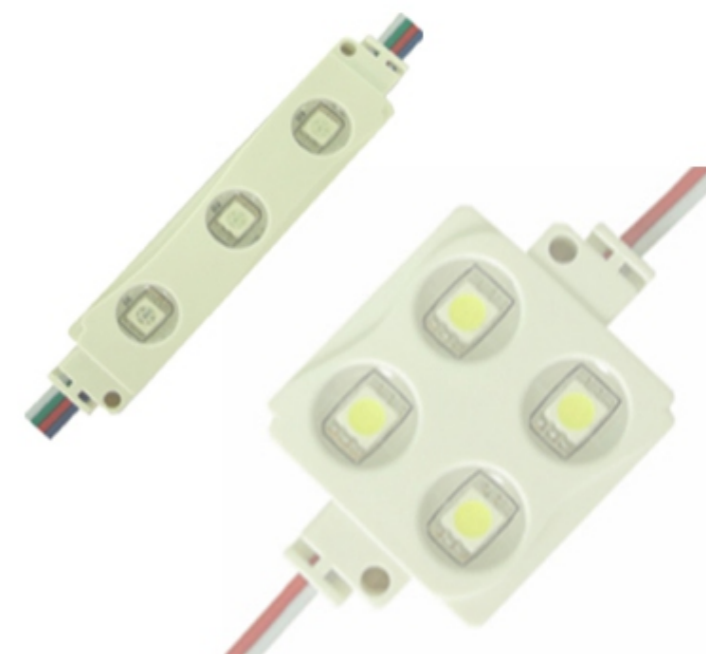

Power Consumption	0.72W	1.2W	0.96W	1.5W
LED Qty	3	3	4	4
Lumens(Lm)	47	86	65	110
Input Voltage	DC12V			
Dimmable	Yes			
LEDs Brand	SMD5050	SMD5630	SMD5050	SMD5630
Normal Color	3000K / 4000K / 6000K / Red / Breen / Blue / Yellow			
CRI	>80			
IP Grade	IP65			
dimension(mm)	68x18x6	68x18x6	55x33x6	55x33x6
Base	connector			
Beam angle	120 Degree			
Operate Temperature	-25° C~40° C			
Certificate	CE & RoHS			
pcs/series	20	20	20	20
LED Distance	76	76	76	76
series/bag	50			
Carton dimension(cm)	45x25x26			
Qty/Carton	1000			
Carton Weight(kg)	12	12	19	19



88L-HighPower Modules IP64

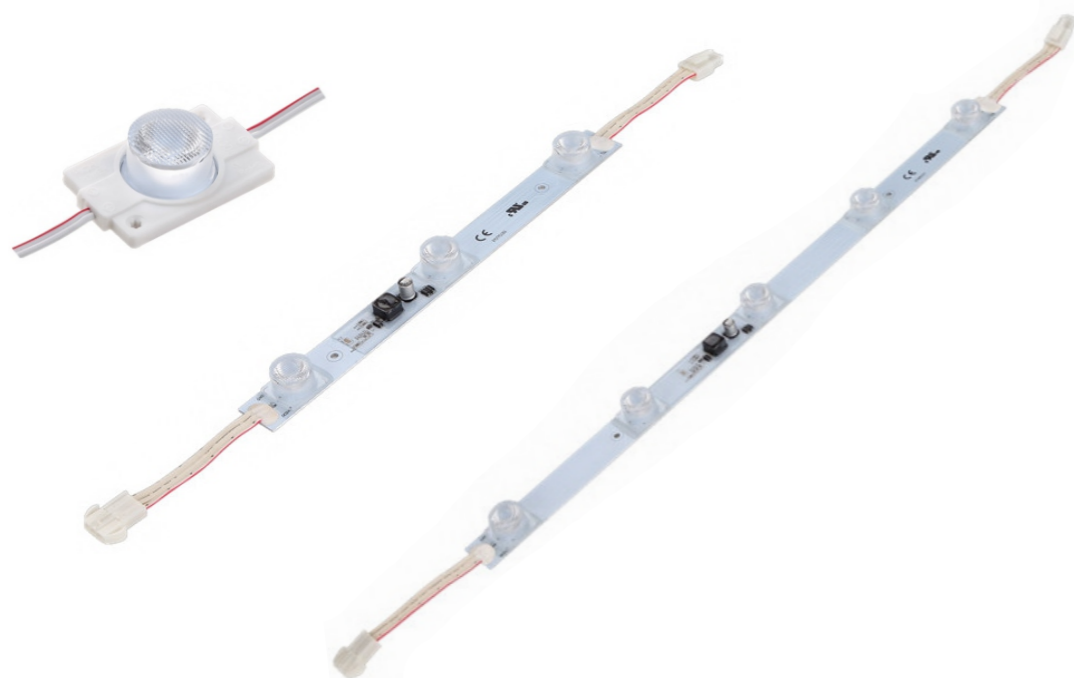

Power Consumption	2W	9W	15W	7.2W	6W
LED Qty	1	3	5	30	8
Lumens(Lm)	250	635	1055	620	480
Input Voltage	DC12V	DC24V		DC12V	DC24V
Dimmable	No				
LEDs Brand	Cree/Osram SMD 3535		Epistar SMD 2835		
Normal Color	3000K / 4000K / 6000K / Red / Breen / Blue / Yellow				
CRI	>80				
IP Grade	IP65				IP33
dimension(mm)	45x32x18	295x28x16	495x28x16	982x36x10	640x20x7
Base	connector				
Beam angle	15x45			160	170
Operate Temperature	-25° C~40° C				
Certificate	CE & RoHS				
pcs/series	10	20	1	1	10
LED Distance	44	44	98	116	80
Backlight Distance	200	160	200	240	35
Carton dimension(cm)	49x45x22	49x45x22	37x24x27	37x24x27	59x24x27
Qty/Carton	600	1000	50	50	120
Carton Weight(kg)	13.5	13.5	6.8	6.8	6.7

88L-Smart Modules

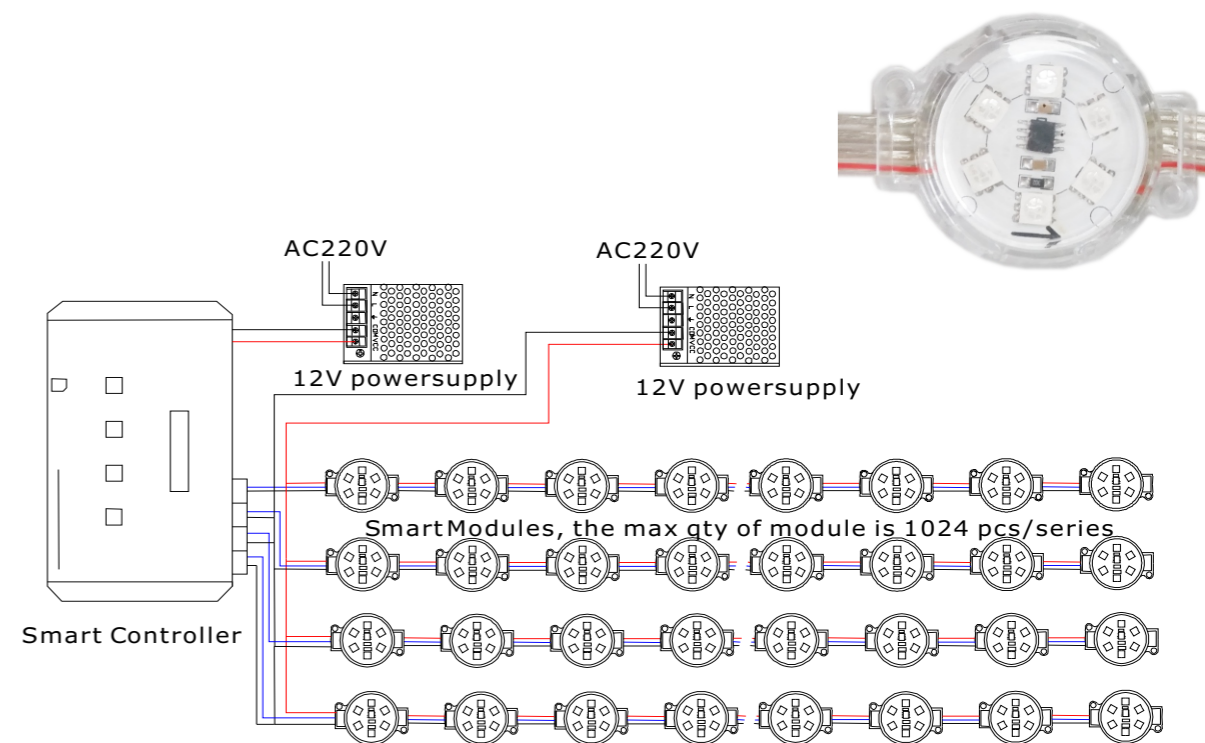

Power Consumption	1.44W Max
LED Qty	6
Lumens(Lm)	75
Input Voltage	DC12V / DC24V
Dimmable	Yes (with smart controller)
LEDs Brand	SMD5050
Normal Color	RGB / 3000K / 4000K / 6000K / Red / Breen / Blue
Main IC	Smart SOP8
IP Grade	IP65
dimension(mm)	52x39x14
Base	connector
Beam angle	120 Degree
Operate Temperature	-25° C~40° C
Certificate	CE & RoHS
pcs/series	150pcs with 3x1.5M3 Cable
LED Distance	87
series/bag	50
Carton dimension(cm)	25x25x25
Qty/Carton	150
Carton Weight(kg)	4



LED Decoration Light Product Features

Scope of Application

- Residence, Square.
- Backlighting, Advertising.
- Bank, Hospital
- Hotel, Exhibition hall.
- Restaurant, School
- Shopping Mall and other lighting places.

- Energy saving long service life.
- Small, flexible.
- Kinds of color options.
- DC5V / DC12V constant voltage input.
- Instant start, no flickering, no humming.
- Easy to install and operate, different bases available.
- No mercury and lead, green and eco-friendly.
- High CRI, no UV, no IR and soft light, safe to eyes.



88L-Decoration Light Strip



Type	button cell(CR2032)	AA Battery(1.5V)	USB	Adapter
LED type	SMD 0603			
LED Qty	10pcs/meter			
Lumens(Lm)	6Lm/LED			
Input Voltage	3V	3V / 4.5V / 6V	5V	DC12V
Light Color	3000K/ 6000K/ Red / Green / Blue / Yellow/ Pink / Purple / RGB			
IP Grade	IP68			
Control able	Available			
Max Length	2 meter 26 LED	5 meter 50 LED	10 meter 100 LED	30 meter 300 LED
Cut able	Yes			
Operate Temperature	-25° C~40° C			
Certificate	CE & RoHS			
Beam angle	360 Degree			
Contrller	Nop	Key	IR Remote controller / Key	
Cable size	0.4mm copper			
Base	Nop	Nop	USB	DC5.5 Connector
Touch able	Safe to touch			
Qty / Carton	500	400	200	100
Carton Size	58x38x28 cm			
Carton Weight	10Kg			

88L-Decoration Light Strip



Type	AC110 / AC220V			
LED type	DIP F5			
Lumens(Lm)	6Lm/LED			
voltage	AC110 / AC220V			
Light Color	3000K/ 6000K/ Red / Green / Blue / Yellow/ Pink / Purple / RGB			
IP Grade	IP65			
Control able	Available			
Max Length	100m 800LED	100m 1050LED	100m 1200LED	100m 2000LED
Cut able	Nop			
Operate Temperature	-25° C~40° C			
Certificate	CE & RoHS			
Beam angle	360 Degree			
Contrller	Key			
Pattern	Flash / Dim / Gradual change			
Cable Size	1.8mm copper wire			
Base	Plug			
Touch able	No (Dange to Touch)			
Qty / Carton	30			
Carton Size	58x38x28 cm			
Carton Weight	15kg			

88L-Decoration Light Net

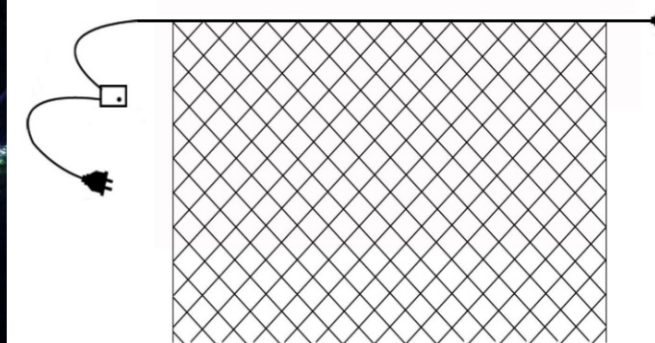
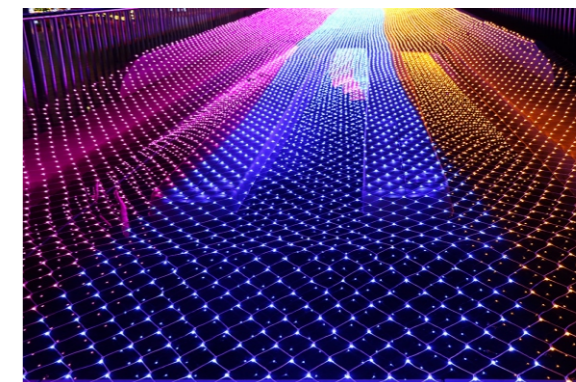

Type	AC220V			
LED type	DIP F5			
Lumens(Lm)	5 Lm/LED			
voltage	AC220V			
Light Color	3000K/ 6000K/ Red / Green / Blue / Yellow/ Pink / Purple / RGB			
IP Grade	IP65			
Control able	Available			
Max Length	1.5x1.5m 120LED	2x3m 320LED	4x6m 868LED	8x10m 2650LED
Cut able	Nop			
Operate Temperature	-25° C~40° C			
Certificate	CE & RoHS			
Beam angle	360 Degree			
Contrller	Key			
Pattern	Flash / Dim / Gradual change			
Cable Size	1.8mm copper wire			
Base	Plug & cascade connect able to make synchronization			
Touch able	No (Dange to Touch)			
Qty / Carton	20			
Carton Size	58x38x28 cm			
Carton Weight	15kg			

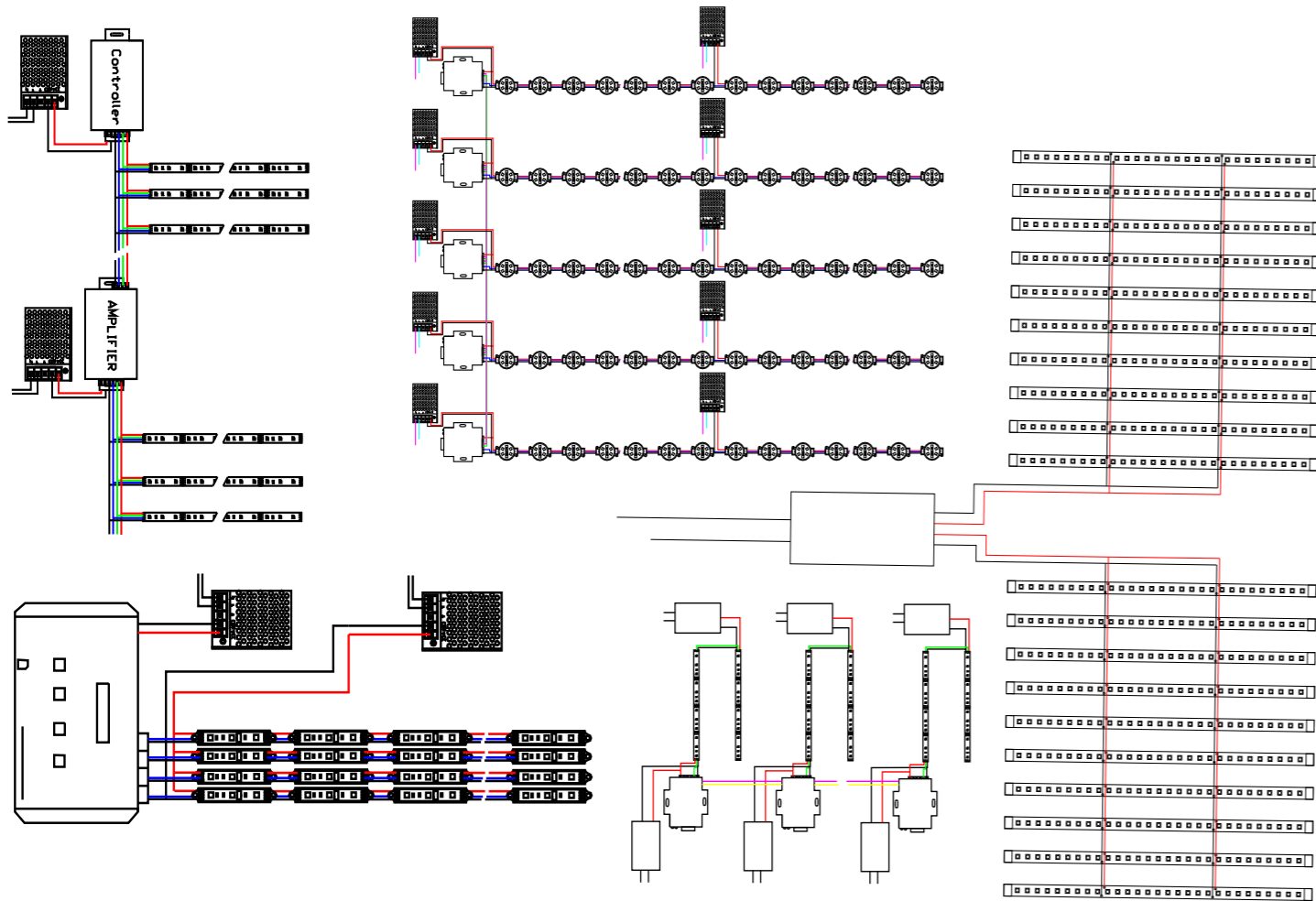

LED Accessory

Scope of Application

- LED Strip Light.
- LED Rigid Bar.
- LED Modules.
- LED Panel Lights.
- LED Controllers.
- Other LED projects.

Product Features

- Small for special application.
- Kinds of type options.
- Kinds of shape options.
- Easy to install and operate.
- No mercury and lead, green and eco-friendly.



88L-ACC Open quick connectors



Type	W08L2	W10L2	W10L3	W08L4	W10L4	W10L5	W12L4
Port size	8mm	10mm		8mm	10mm		12mm
Dimension(mm)	12x13x5	14x13x5		12x13x5	14x13x5		17x13x5
Pin Qty	2	2	3	4	4	4	4
Channel Qty	1	1	2	3	3	3	3
IP Grade	IP44						
Operate Temperature	-30 ° C ~ 60 ° C						
Certificate	CE & RoHS						
Qty/Bag	500						
Qty / Carton	1000						
Carton Size	25x25x25cm						
Carton Weight	8.5kg						

88L-ACC Open Wire connectors

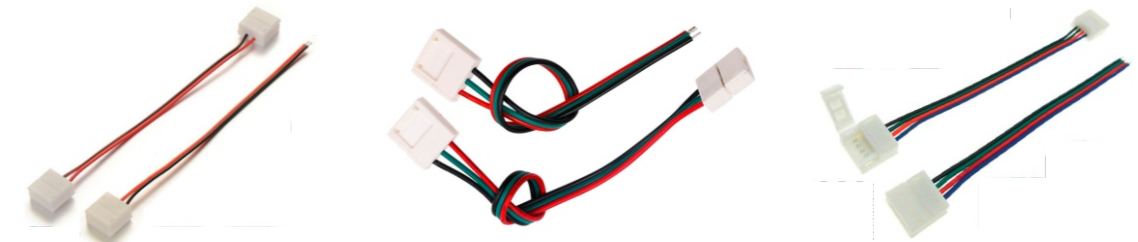

Type	WQ08L21/22	WQ10L31/32	WQ10L41/42	WQ10L51/52
Port size	8mm/10mm	10mm	8mm/10mm/12mm	10mm/12mm
Default Wire Length	15cm			
Pin Qty	2	3	4	5
Channel Qty	1	2	3	4
IP Grade	IP44			
Operate Temperature	-30 ° C ~ 60 ° C			
Certificate	CE & RoHS			
Qty/Bag	500			
Qty / Carton	500			
Carton Size	25x25x25cm			
Carton Weight	5.5kg			

88L-ACC Closed quick connectors



Type	2.54L2/4/5	2.54T2/4/5	2.54X2/4/5	2.54L1To1/2/3/4/5/6/10
Hole Size	0.6mm			
Hole Distance	2.54mm			
Pin Qty	2	4	5	4
Channel Qty	1	3	4	3
IP Grade	IP44			
Operate Temperature	-20° C ~ 40° C			
Certificate	CE & RoHS			
Qty/Bag	500		500	
Qty / Carton	1000		500	
Carton Size	25x25x25cm			
Carton Weight	8.5kg			

88L-ACC FPC connectors



Type	FPCL2	FPCT2	FPCX2	FPCL4	FPCT4	FPCX4	FPCL5	FPCT5	FPCX5
Port Size	8mm/10mm			10mm			10mm/12mm		
Max Current	8A			6A			6A		
Pin Qty	2			4			5		
Channel Qty	1			3			4		
IP Grade	IP44								
Operate Temperature	-30° C ~ 60° C								
Certificate	CE & RoHS								
Qty/Bag	1000								
Qty / Carton	5000								
Carton Size	25x25x25cm								
Carton Weight	4.5kg								

88L-ACC Wire connectors



Type	WPCH1	WPCH2	WPCT1	WPCT2
Dimension	25x7x7mm	25x11x7mm	25x13x7mm	25x17x7mm
Color	Red / Transpare			
Pin Qty	1	2	1	2
Channel Qty	1	2	1	2
IP Grade	IP44			
Operate Temperature	-30° C ~ 60° C			
Certificate	CE & RoHS			
Qty/Bag	500			
Qty / Carton	2500			
Carton Size	25x25x25cm			
Carton Weight	4.5kg			

88L-ACC Wire quick connectors



Type	WQCT2	WQCT3	WQCT4	WQCH4	WQCT5	WQCH6
Dimension(mm)	21x13x15	21x17x15	21x21x15	38x14x13	21x27x15	38x17x15
Max Current	32A					
Pin Qty	2	3	4	4	5	6
Channel Qty	1			2	1	3
IP Grade	IP44					
Operate Temperature	-30° C ~ 60° C					
Certificate	CE & RoHS					
Qty/Bag	500					
Qty / Carton	2500					
Carton Size	25x25x25cm					
Carton Weight	4.5kg					

88L-ACC Installation Clips



Type	INSC1	INSC2	INSC3
Fit Size	8mm/10mm/12mm	8mm/10mm	8mm/10mm/12mm/15mm
Screw Size	2.6x6x6mm		
Color	white/Transparent	white/Transparent	white/Transparent
Inner width	8mm/10mm/12mm	8mm/10mm	10mm/12mm/14mm/17mm
Material	Plastic		Plastic/Silicon
Operate Temperature	-20° C ~ 50° C		
Certificate	CE & RoHS		
Qty/Bag	1000		
Qty / Carton	5000		
Carton Size	25x25x25cm		
Carton Weight	4.5kg		

88L-ACC DC connectors



Type	DC1To2/3/4/5/6/8/10	DCToWL	DCSwitch	DCToClip	DCToScrew
Input Port	F DC5.5	F DC5.5	DC5.5	DC5.5	DC5.5
Max Current	8A	6A	8A	5A	
Pin Qty	2				
Channel Qty	1				
IP Grade	IP44				
Operate Temperature	-30° C ~ 60° C				
Certificate	CE & RoHS				
Qty/Bag	100	100	100	100	100
Qty / Carton	300	500	500	500	500
Carton Size	25x25x25cm				
Carton Weight	4.5kg				

88L-ACC Waterproof connectors



Type	WPC1	WPC2	WPC3
Input Port Size	2-84mm	5-14mm	<10mm
Max Current	Request upon Cable	18A	20A
Pin Qty	Request upon Cable	2P / 3P / 4P	2P / 3P / 4P
Channel Qty	M8---M100	121x27mm	97x66-24mm
IP Grade	IP67		
Operate Temperature	-20° C ~ 50° C		
Certificate	CE & RoHS		
Qty/Bag	100	100	100
Qty / Carton	200	200	100
Carton Size	25x25x25cm		
Carton Weight	7Kg		

88L-ACC Wire quick connectors



Type	2.54FToWL4	2.54MP4	2.54FP4	2.54FQL1/2	USBToWL
Input Port	2.54FP4	2.54FP4	2.54MP4	2.54MP4	USB
Max Current	4A	6A	6A	4A	
Pin Qty	4	1--40		4	2
Channel Qty	3	3	3	3	1
IP Grade	IP44				
Operate Temperature	-30° C ~ 45° C				
Certificate	CE & RoHS				
Qty/Bag	100	500	500	100	100
Qty / Carton	500	5000	5000	500	500
Carton Size	25x25x25cm				
Carton Weight	4.5kg				

PROJECTS

PROJECTS

