

LED BENDABLE STRIP LIGHTS
PRODUCT SERIES DATASHEET



LED Bendable Strip Light

88Light 2835 LED Bendable Flexible Strip light is ideal for Backlighting, Decoration and Advertising. With the 3M adhesive backing, the Strip can be mounted easily in anywhere. It is widely used in Shopping Mall, Parking lots, Bus, Bank, Living Room, Cafe and so on. This product is CE RoHS, FCC approved.



Applications:



PRODUCT FEATURES

- Lightweight and slim, suitable for small spaces.
- Flexible, bendable, it's easy to bend for a variety of shapes.
- High quality single color, high brightness, low luminance decay SMD Chip.
- A variety of colors to choose.
- It is trimmable every group LED. Each group that can be cut.
- 12V/24V DC low voltage, low power consumption, low heat, higher security.
- Long lifespan with free maintenance.
- Allow frequent on-off.
- Dimmable or non-dimmable available.
- 3M adhesive backing for easy installation.
- Working temperature: -20 ~ +40°C



LED BENDABLE STRIP LIGHTS
PRODUCT SERIES DATASHEET



PRODUCT DIAGRAM

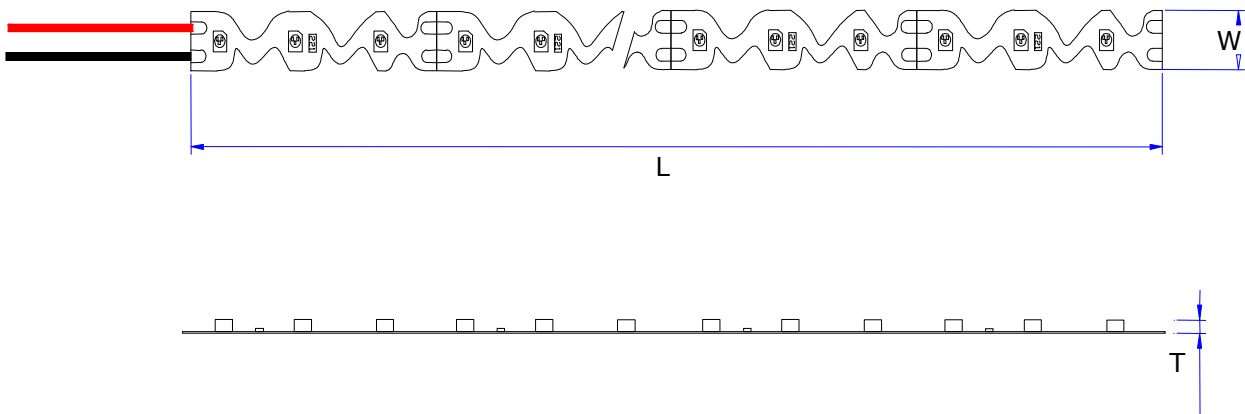

Product Name	L ¹ [mm]	W [mm]	T ² [mm]
88L-LS-2835-60-BD-N-12	5000	6	2
88L-LS-2835-60-BD-DF-12	5000	6	2
88L-LS-2835-60-BD-N-24	5000	8	2
88L-LS-2835-60-BD-DF-24	5000	8	2

Note 1: The dimensions of the strips don't change with the LED color (NW-Natural white, CW-Cool White), or LED number/5m.
Note 2: The IP64 Waterproof strips "DF" is Nano waterproof.

TECHNICAL DATA

Electrical data^{3, 4}:

Product Name	Input Voltage [Vdc]	LED/group	Power [w/m]	Dimmable [Y/N]	LED Qty [LED/m]	IP grade
88L-LS-2835-60-BD-N	12/24	3/6	14	Y	60	IP20
88L-LS-2835-60-BD-DF	12/24	3/6	14	Y	60	IP65

Note 3: Absolute ratings @ 25°C
Note 4: Tolerance of measurement of power intensity±8%, because of the voltage drop.

LED BENDABLE STRIP LIGHTS
PRODUCT SERIES DATASHEET



TECHNICAL DATA

Optical Characteristics^{3, 5}:

Product Name	Color	Color Temperature [°K]	Luminous Flux [lm/m]	CRI [Ra]	Beam angle [°]
88L-LS-2835-60M-BD	Cool white	6000	1230	70/90/95	120
88L-LS-2835-60N-BD	Nature white	4000	1200	70/90/95	120
88L-LS-2835-60W-BD	Warm white	3000	1170	70/90/95	120

Note 3: Absolute ratings @ 25°C

Note 5: Tolerance of measurement of luminous intensity±9%.

Voltage-Illuminance Characteristic^{3, 6}:

Model: 2835-120LED-12V-6000K 6mm width FPC.

88L-LS-2835-120M-12	0m	0.5m	1.0m	1.5m	2.0m	2.5m	3.0m	3.5m	4.0m	4.5m	5.0m
Voltage(v)	12.05	11.12	10.43	9.81	9.52	9.34	9.02	8.56	8.36	8.08	7.88
Brightness(Lux)	665	617	587	556	518	487	458	421	389	352	313

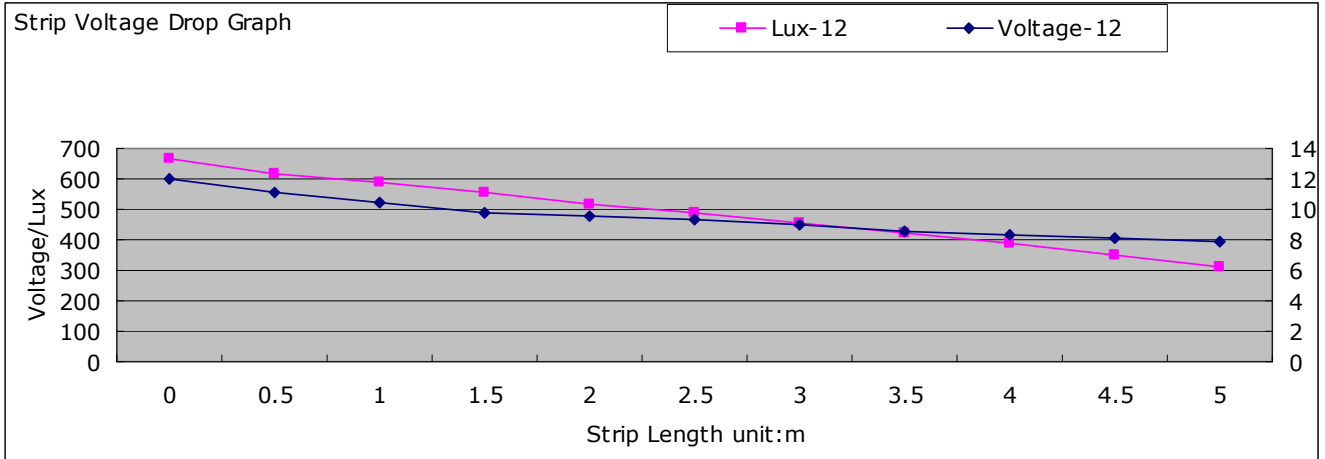

LED BENDABLE STRIP LIGHTS
PRODUCT SERIES DATASHEET



TECHNICAL DATA

Voltage-Illuminance Characteristic ^{3, 6}:
Model: 2835-120LED-24V-6000K 8mm width FPC.

88L-LS-2835-120M-12	0m	0.5m	1.0m	1.5m	2.0m	2.5m	3.0m	3.5m	4.0m	4.5m	5.0m
Voltage(v)	23.8	23.3	22.8	22.3	22	21.7	21.4	21.2	21.1	21	21
Brightness(Lux)	1426	1377	1245	1218	1154	1074	1042	1036	953	988	981

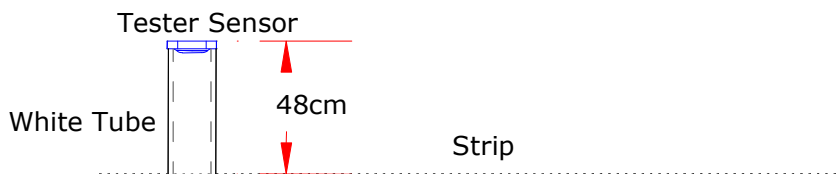
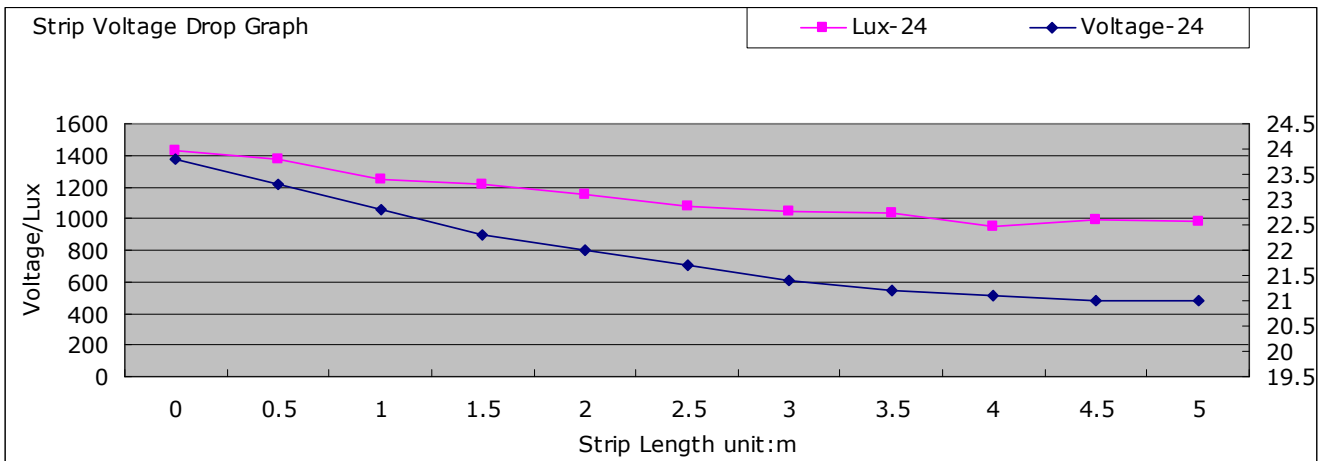

Note 3: Absolute ratings @ 25°C.

Note 6: Testing voltage is DC12V/DC24V, standard LED adaptor and one side input from the beginning side.

LED BENDABLE STRIP LIGHTS PRODUCT SERIES DATASHEET



PRODUCT INSTALLATION

Hard-wired Driver connection:

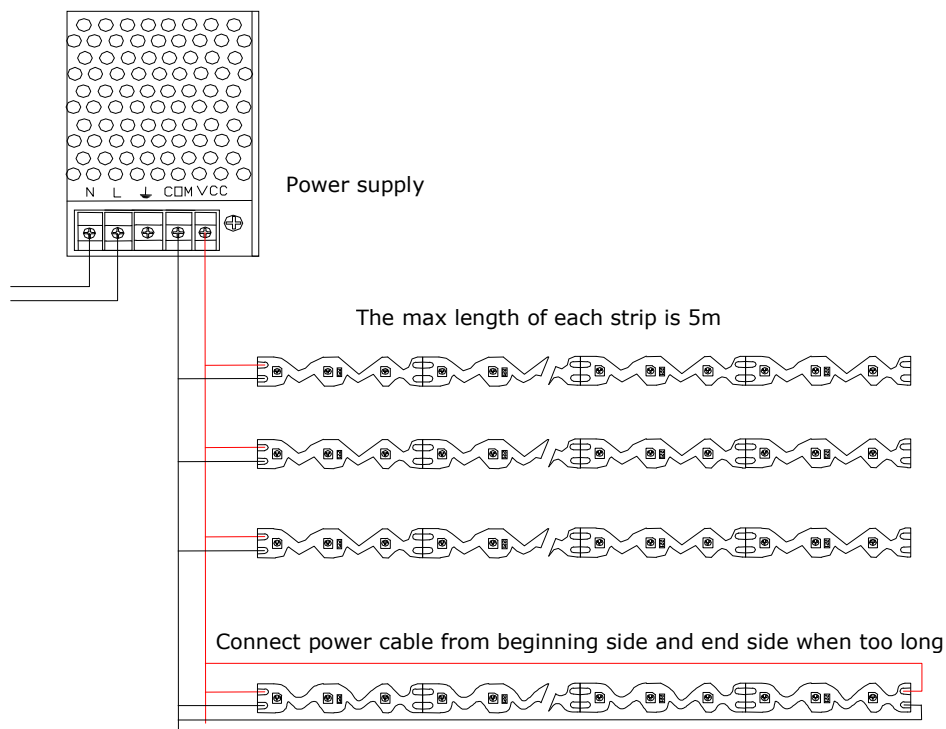

Note 7: When 5 meters strip is connected, please connect input cable from beginning side and end side at the same time to reduce brightness drop.

SAFETY

1. **Always** consult a qualified, licensed electrician prior to the installation of this product.
2. **Always** pre-test your strip light assembly by making all connections and connecting the strip to a power supply and ensure that all components are joined properly before they are installed.
3. It is recommended that adequate airflow and heat sink be taken into account in the application and installation of this product. Improper thermal management may lead to premature failure.
4. Exceeding the operating temperature values may damage LED chips by reducing the total lamp life and lumen output, and inversely impact color consistency.
5. Avoid voltage drops by using a dedicated line for each maximum power consumption line.

LED BENDABLE STRIP LIGHTS PRODUCT SERIES DATASHEET



SAFETY

6. This product should only be cut at "cut points," if It's cut at the wrong place, then some LED will not work.
7. "Voltage drop" is a gradual lessening of power through a wire over a long distance. The farther the light is from the power source, the more voltage drop will occur. Voltage drop becomes a significant factor in any LED light application when the distance between the lights and the power source is greater than 15 feet. Consult a licensed electrician and an online voltage drop calculator to learn what gauge wire will work best for your configuration.
8. The manufacturer rates each power supply for maximum power output at optimum thermal and voltage conditions. As with any power supply, true actual maximum continuous current output depends upon various environmental factors such as ambient temperature, line voltage fluctuations, and orientation that may affect heat dissipation. For optimum performance, make sure the load is between 50% and 80% of the total capacity of the power supply.
9. LED products are continuously being improved upon in ever-shortening manufacturing cycles. LED color temperature (kelvin), lumen output, and product appearance can change from order to order. Please note that variation in color temperature (kelvin) is commonly +/- 250k and brightness (lumens) is +/- 10%.

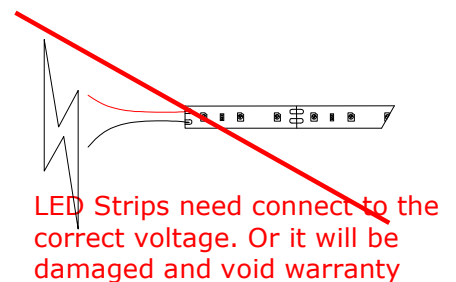
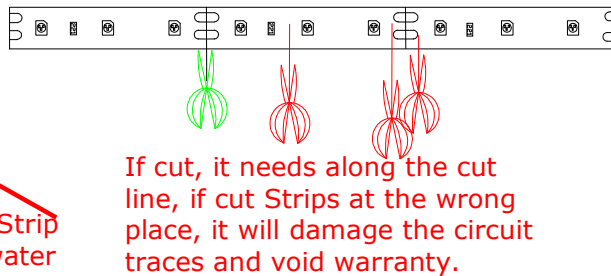
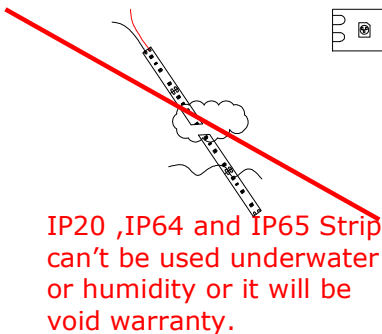

LED BENDABLE STRIP LIGHTS
PRODUCT SERIES DATASHEET



PACKING

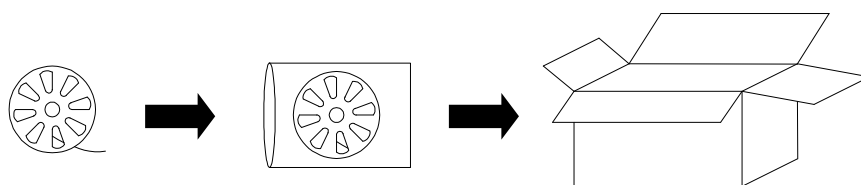

The default carton dimension is 51x38x28cm, 50R/Box, 5m/Roll.

Product Name	Pcs/box	Box dimensions	Gross Weight
88L-LS-2835-60-BD-N	100R/Box	51x38x28cm	12Kg
88L-LS-2835-60-BD-DF	100R/Box	51x38x28cm	12Kg

Note 8: the package information is only for reference.

OTHER 88Light PRODUCTS:

For more information about 88Light products, or to use our online energy saving calculation software please visit our website

www.88light.com

DISCLAIMER:

88Light reserves the right to modify the design of our products as part of the company’s program of continuous improvement. 88Light cannot guarantee to match existing installed product for subsequent orders or replace the product exactly to match the product you are replacing in product appearance, color, or brightness. Specifications are subject to change without notice.